

 *Stone Magic*

*Fireplace  
Gallery*



## ***Stone Magic***

mantels impart a graceful and lasting elegance to any home. These fireplace treatments provide a rich, old world charm without the expense. Our cast stone has the look and feel of limestone, but is less expensive, load bearing, maintenance-free and we can do intricate designs at a fraction of the cost.

Most of our elegant designs are suitable for metal as well as masonry fireboxes. If you need help with an existing firebox that doesn't quite fit, give us a call. We can probably make it work for you.

***Each piece of your stone fireplace is hand made for beauty and durability. The photo below shows one of our craftsmen working on the keystone for the Bordeaux fireplace.***



Throughout the catalog, you may see mantels represented only in drawings.

If you purchase one of these and furnish a useable photo of the final installation, Stone Magic will rebate \$300 to you. Please call for more information.



# Paramount Collection

Our "**Best Seller List**" of beautiful and elegant surrounds.

Many of these are currently in inventory.

Bordeaux	6-7
Bristol	8-9
Barrington	10
Cherbourg	11
Castlegate	10-11
Falkland	12-13
Gothic	14-15
Guardians	18-19
Guardians 39"	20
Imperial	21
Leaf Tudor	22-23
Longleat	24-25
Louie	26-27
Marquis	28
Martine	29
Polo	30-31
Provence	32-35
Regency	36-37
Windsor	38-39

# Premiere Collection

Includes our newer and larger designs, as well as our individual upper mantels.

With this large selection, you are sure to find the surround that meets your needs.

Alameda	40	Normandie	56
Alhambra	41	Palatine	57
Anton	42	Radcliffe	58
Aspen	43	Richmond	59
Brittany	44	Rochelle	60
Cambridge	45	Scarborough	61
Grand Baroque	46	Scarsdale	62
Columbia	47	Somerset	63
Devonshire	48	Venice	64
DiConte	49	Weldon	65
Emporium	50	Wellesley	66
Fenwick	51	Wyndmere	67
Hamilton	52		
Jocelyn	53	Upper Mantels	68-72
Medallion	54	Hearths	73
Nordic	55		

## Technical Information

Installation Tips	74-75
How to order/crates/color	76
Sales Policies	77

Do you need some help in determining your needs or selecting a style? The following pages include introductory information on fireplace sizes and installation ideas.



Copyright © 2009 by Texas Publishing • Dallas, TX • All rights reserved • Printed in China

301 Pleasant Drive • Dallas, TX 75217 • Toll Free: (800) 597-3606 • Fax: (214) 823-4503 • [www.stonemagic.com](http://www.stonemagic.com) • [info@stonemagic.com](mailto:info@stonemagic.com)

Effective: August 1, 2009

Page 3

# Installation Ideas

Stone Magic mantels are designed to be installed either in new construction or as replacements for existing surrounds. They can be successfully placed over a variety of building materials, including dry wall, stone and brick. Each mantel comes with installation instructions for your mason.



*Above, the Leaf Tudor, with standard hearth, installed with diagonal tiles. The upper mantel is constructed with sheet rock.*



*Above is a Bordeaux with the Bordeaux Radius filler. Additional leg pieces accommodate the extra height.*



*The Castlegate (above) used marble tile as fillers and as a hearth.*

Two frequently asked questions are: "What size do I need?" and "Can an arched surround fit if I have a rectangular firebox?" Any size close to the firebox size will work. Pick a larger version if you want to trim out, like framing and matting a picture. Arched surrounds work beautifully with rectangular boxes. On this page, we have shown several different installations to get your ideas started. As much as possible, the photos inside the catalog are also as installed. The choices are endless and allow you freedom to choose the mantel you prefer.



## Determining Your Needs

Stone Magic carries fireplace surrounds to fit into practically any space requirements. Using the diagram at the left, you can easily determine your existing space requirements. This information will also help your Stone Magic sales technician estimate any special needs.

- X* = Width of the firebox opening.
- Y* = Height of the firebox opening.
- OL* = Distance to nearest obstruction or edge left of the firebox.
- OR* = Distance to nearest obstruction or edge right of the firebox.
- FF* = Distance between firebox and the finished floor.
- RHH* = (If applicable) Height of opening for a Recessed Hearth.
- RHL* = (If applicable) Length of opening for a Recessed Hearth.



## Fireplace Styles

Stone Magic offers many designs and most of these come in several sizes to fit a number of firebox openings. Use the drawing below as a guide to determine sizes. All (except the Guardians) are available with optional flat or raised hearths. Some have matching specially designed hearths. The Guardians, shown on pages 18 and 19, fits only on the Guardians hearth.

Our fireplace surrounds are specified by name and firebox opening size.

- X* = is the maximum width of the opening for the firebox.
- XX* = is the overall width of the fireplace at the widest point, usually the mantel.
- Y* = is the maximum height of the opening for the firebox.
- YY* = is the overall height of the fireplace from stone to stone.
- Z* = is the maximum depth of stone, usually at the mantel.
- ZZ* = is the depth of the stone at the foot of the fireplace.

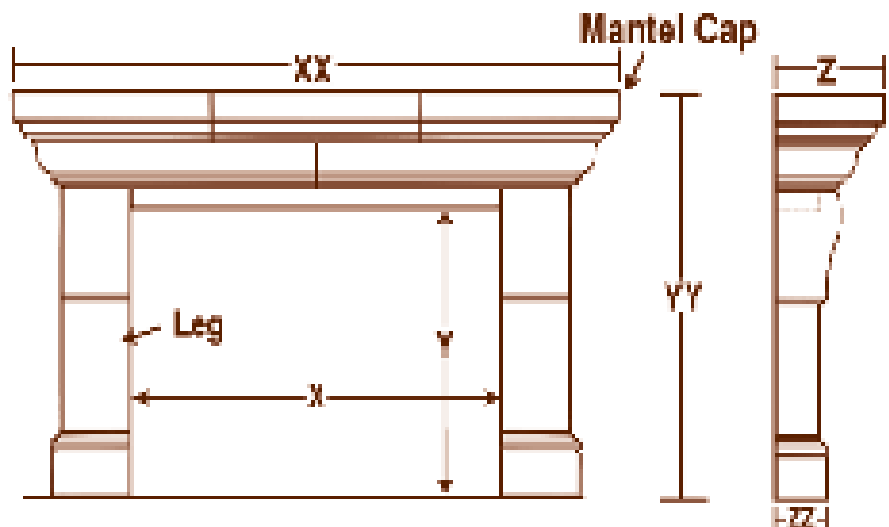

*Bordeaux*™

*Elegant and sophisticated,  
the Bordeaux speaks for  
itself.*

# Bordeaux™

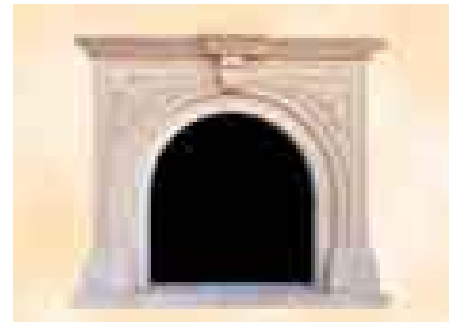

*Fruited Bordeaux  
Now available in 36" & 42".*

The Fruited Bordeaux also uses a different mantel cap that is slightly wider and taller than the other cap.



*Above is a Bordeaux with a coral stone finish to give an aged look.*

Size	X	XX	Y	YY	Z	ZZ	Hearth	Cost	Weight
36"	36"	67 <sup>1</sup> / <sub>4</sub> "	38 <sup>1</sup> / <sub>2</sub> "	55"	12"	9 <sup>3</sup> / <sub>4</sub> "	70"	\$1,890	1368
36" Fruit	36"	72"	38 <sup>1</sup> / <sub>2</sub> "	56 <sup>1</sup> / <sub>4</sub> "	12 <sup>1</sup> / <sub>2</sub> "	9 <sup>3</sup> / <sub>4</sub> "	70"	\$2,090	1376
42"	42"	73 <sup>1</sup> / <sub>4</sub> "	44"	60 <sup>3</sup> / <sub>4</sub> "	12"	9 <sup>3</sup> / <sub>4</sub> "	76 <sup>1</sup> / <sub>4</sub> "	\$2,250	1655
42" Fruit	42"	78"	44"	62"	12 <sup>1</sup> / <sub>2</sub> "	9 <sup>3</sup> / <sub>4</sub> "	76 <sup>1</sup> / <sub>4</sub> "	\$2,450	1661
59"	58 <sup>3</sup> / <sub>4</sub> "	90 <sup>13</sup> / <sub>16</sub> "	50"	64"	12"	9 <sup>3</sup> / <sub>4</sub> "	90"	\$2,825	2069

*All Bordeaux sizes except the 36" with fruit and the 59" are inventoried in Standard Tan color.*

**For hearth information, please refer to page 73.**

**For crate information, please refer to page 76.**

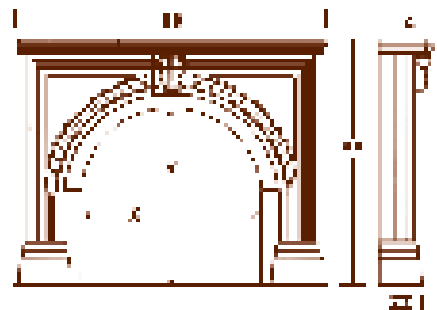



*Great things come  
in small packages...*

*Bristol*™



# Bristol™

Great things come in small packages and the Bristol is no exception. It fits into minimal space, and still makes a dramatic focal point for any room.



Above is the Bristol 36".



Above is the Bristol 42" with extra tall legs to accommodate a raised firebox.

Size	X	XX	Y	YY	Z	ZZ	Hearth	Cost	Weight
36"	36"	60"	35½"	52¾"	5⅛"	3"	60"	\$950	685
42"	42"	66"	35½"	52¾"	6"	3"	66½"	\$1,149	850

The Bristol 42" is inventoried in Standard Tan color.

For hearth information, please refer to page 73.

For crate information, please refer to page 76.

**Major Credit Cards Accepted!**

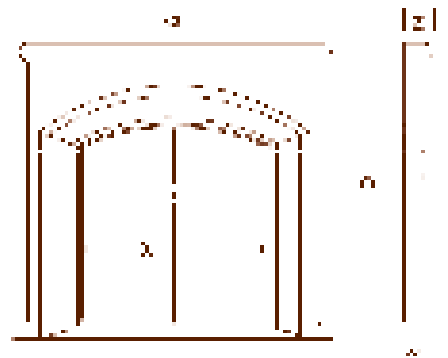

# Barrington™

This time-less classic will give any home the presence of elegance. A cast stone fireplace will be the visual center piece of any room.



Premiere Collection

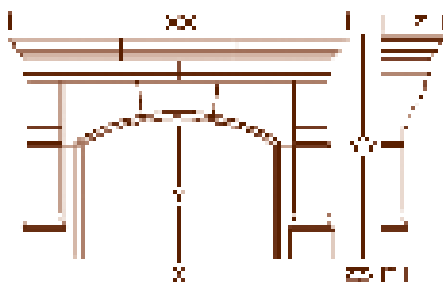

Size	X	XX	Y	YY	Z	ZZ	Hearth	Cost	Weight
36"	36"	72½"	31"	54"	15¾"	6½"	76¼"	\$2,068	1599
42"	42"	78½"	33⅝"	54"	15¾"	6½"	80"	\$2,068	1599
46"	46⅛"	82½"	33⅝"	54"	15¾"	6½"	80"	\$2,290	1620
48"	48"	84½"	34⅛"	54"	15¾"	6½"	87"	\$2,790	1809

*The Barrington 42 & 46 are inventoried in Standard Tan.*

*For hearth information, please refer to page 73.*

*For crate information, please refer to page 76.*

**Major Credit Cards Accepted!**



# Cherbourg™

Reminiscent of France before the Revolution, the Cherbourg combines the curves of the Louies with straighter lines in the legs for a unique look.

*The Cherbourg full height, at left, with hearth and marble filler.*



## Cherbourg Full Height

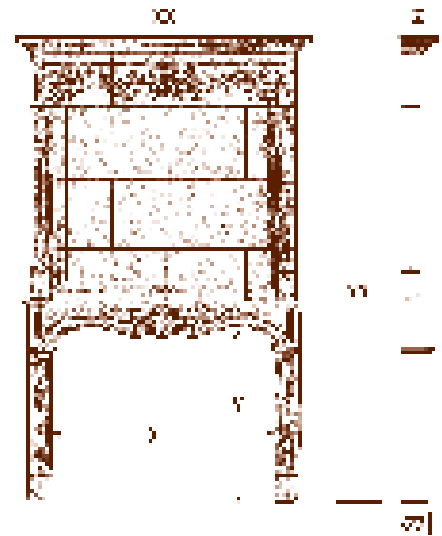

## Cherbourg Lower Mantel

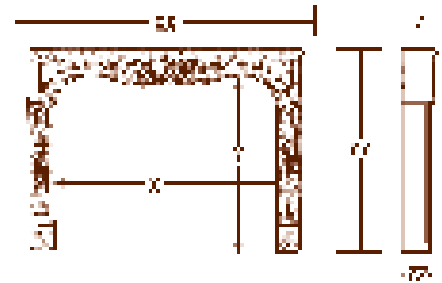

*At left is a close up of the Cherbourg center medallion.*

Size	X	XX	Y	YY	Z	ZZ	Hearth	Cost	Weight
56" Full	56 <sup>1</sup> / <sub>4</sub> "	78 <sup>3</sup> / <sub>4</sub> "	44 <sup>3</sup> / <sub>4</sub> "	120 <sup>7</sup> / <sub>16</sub> "	10 <sup>1</sup> / <sub>2</sub> "	8 <sup>3</sup> / <sub>8</sub> "	76 <sup>1</sup> / <sub>4</sub> "	\$3,944	2630
56" Lower	56 <sup>1</sup> / <sub>4</sub> "	73 <sup>3</sup> / <sub>4</sub> "	44 <sup>3</sup> / <sub>4</sub> "	54 <sup>1</sup> / <sub>4</sub> "	10 <sup>1</sup> / <sub>2</sub> "	8 <sup>3</sup> / <sub>8</sub> "	76 <sup>1</sup> / <sub>4</sub> "	\$2,390	1315

*The Cherbourg Lower Mantel is inventoried in Standard Tan.*

301 Pleasant Drive • Dallas, TX 75217 • Toll Free: (800) 597-3606 • Fax: (214) 823-4503 • www.stonemagic.com • info@stonemagic.com

Effective: August 1, 2009



*Castlegate™*



# Castlegate™

Reminiscent of the large fireplaces common in Medieval times, the Castlegate lends its own strength to any room.

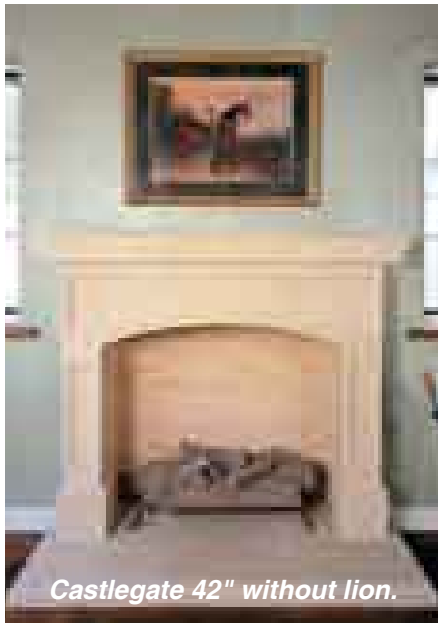

Castlegate 42" without lion.



At left, a Castlegate 36" with no lion on a slightly raised hearth.



Shown in the photo on page 10 is the 54" Castlegate with the larger, open mouth lion. The 36" and 42" have a slightly smaller, closed mouth lion, above.

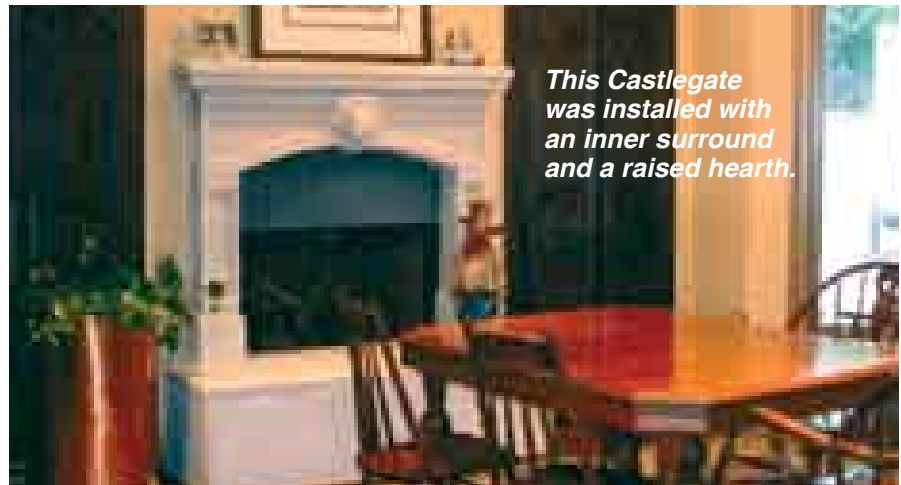

This Castlegate was installed with an inner surround and a raised hearth.

Please specify with or without lion .

Size	X	XX	Y	YY	Z	ZZ	Hearth	Cost	Weight
36"	36"	54 $\frac{1}{2}$ "	32 $\frac{3}{4}$ "	47 $\frac{1}{8}$ "	9 $\frac{1}{8}$ "	7"	57 $\frac{1}{2}$ "	\$1,200	869
42"	42"	58 $\frac{1}{4}$ "	32 $\frac{3}{4}$ "	47 $\frac{1}{8}$ "	9 $\frac{1}{8}$ "	7"	60"	\$1,300	876
42" Tall	42"	58 $\frac{1}{4}$ "	39 $\frac{1}{8}$ "	53 $\frac{1}{2}$ "	9 $\frac{1}{8}$ "	7"	60"	\$1,300	968
54"	53 $\frac{1}{2}$ "	79 $\frac{5}{8}$ "	44"	64"	12 $\frac{1}{2}$ "	9 $\frac{1}{2}$ "	80"	\$2,350	2000

All Castlegates, with and without lion, are inventoried in Standard Tan color.

For hearth information, please refer to page 73.

For crate information, please refer to page 76.

Major Credit Cards Accepted!

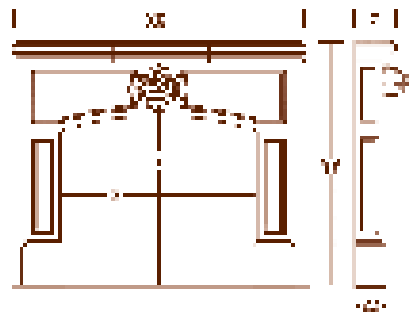

*Bring the cheer  
of Olde England  
into your den or  
great room.*



*Falkland*™

# Falkland™

The deeply embossed Oak Leaf banding and dramatic Lion Shield add depth and beauty to any setting. Now, the Falkland can be customized with blank shield or with the Oak Leaf banding all the way across. Call for more information.



Above is a Falkland Full with raised hearth.

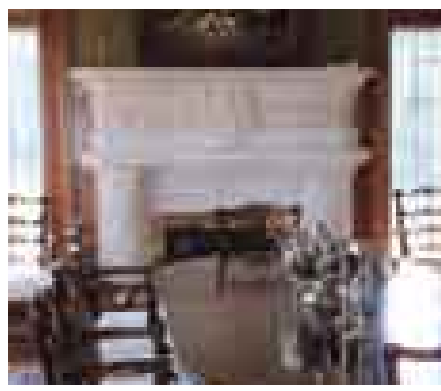

For the Falkland Mid-Height shown above, the column legs were shortened to fit the firebox.



At left is a Falkland Lower Mantel on a standard hearth.

## Falkland Full Height

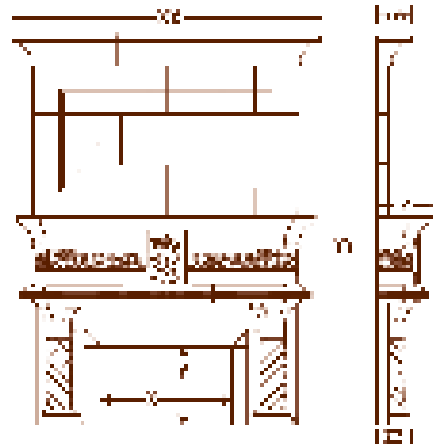

## Falkland Mid-Height

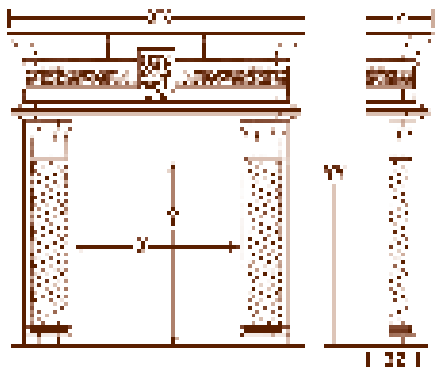

## Falkland Lower Mantel

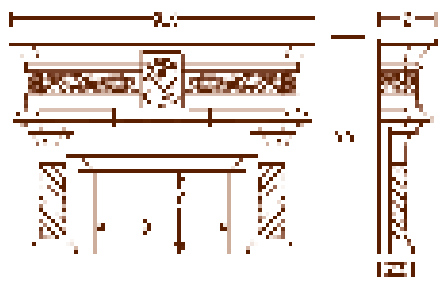

## Falkland Hearth



Size	X	XX	Y	YY	Z	ZZ	Hearth	Cost	Weight
42" Full	42"	94"	24"	117 <sup>7</sup> / <sub>8</sub> "	16 <sup>1</sup> / <sub>4</sub> "	10 <sup>1</sup> / <sub>2</sub> "	90"	\$5,246	4090
42" Lower	42"	90 <sup>1</sup> / <sub>2</sub> "	24"	63"	16 <sup>1</sup> / <sub>4</sub> "	10 <sup>1</sup> / <sub>2</sub> "	90"	\$3,671	2938
44" Mid-Height	44"	81 <sup>1</sup> / <sub>2</sub> "	54"	92"	16 <sup>1</sup> / <sub>4</sub> "	11 <sup>3</sup> / <sub>4</sub> "	76 <sup>1</sup> / <sub>4</sub> "	\$3,955	3414
Falkland Hearth	96"	-	15"	-	20"	-	-	\$550	561

The Falkland raised hearth is available, or use our optional flat, or raised hearth.



The Falkland Lower Mantel is inventoried in Standard Tan color.



*Gothic*™



# Gothic™

Simply a statement, The Gothic is sure to warm the home and the mood.



Paramount Collection

Size	X	XX	Y	YY	Z	ZZ	Hearth	Cost	Weight
36"	36"	62½"	40"	54"	12⅛"	4½"	66½"	\$1,350	878
42"	42"	68¾"	40¾"	54"	12⅛"	4½"	70"	\$1,425	938
48"	48"	74¾"	41¼"	54"	12⅛"	4½"	76¼"	\$1,500	1281

All three Gothic sizes are inventoried in Standard Tan color.

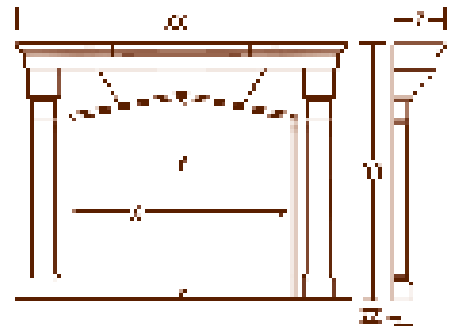

For hearth information, please refer to page 73.

For crate information, please refer to page 76.

**Major Credit Cards Accepted!**



# Guardians™

The Guardians can be customized in many ways. This one has a special arch over the firebox and a coral stone finish. Please call for pricing for your custom Guardians.

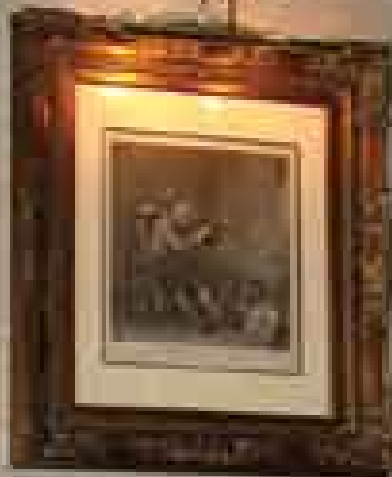

# Guardians™

Elegant and ornate, this fireplace surround will enhance a room with the flavor of High Gothic architecture. The Guardians will not fit on our optional flat or raised hearths.



Left is the Guardians with the gothic arch interior surround, sitting on the Guardians hearth.



Left is a customized Guardians using smooth columns instead of the Guardian Dogs. Other columns could also be used. Please call for pricing.

## Guardians Lower Mantel Square Opening

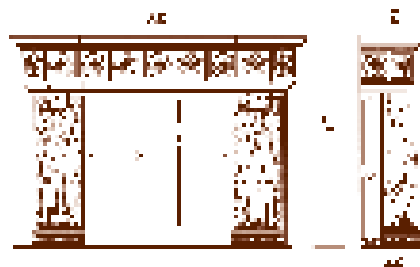

## Guardians Full Height Arched Opening

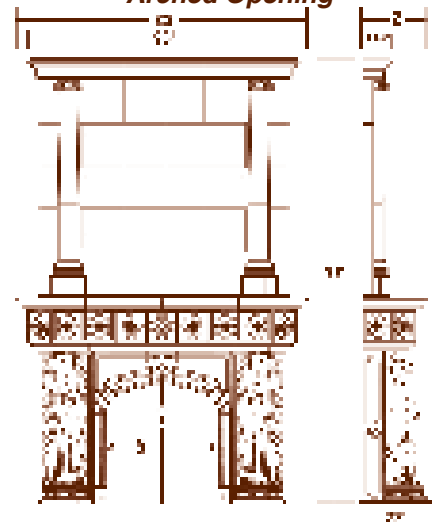

## Guardians Hearth



Size	X	XX	Y	YY	Z	ZZ	Hearth	Cost	Weight
42" Gothic Full	42"	107 <sup>1</sup> / <sub>8</sub> "	46"	163 <sup>1</sup> / <sub>2</sub> "	24"	24"	Guardians	\$6,859	7960
42" Gothic Lower	42"	107 <sup>1</sup> / <sub>8</sub> "	46"	75 <sup>3</sup> / <sub>4</sub> "	24"	24"	Guardians	\$4,649	5111
52" Square Full	52"	107 <sup>1</sup> / <sub>8</sub> "	45"	163 <sup>1</sup> / <sub>2</sub> "	24"	24"	Guardians	\$6,399	7679
52" Square Lower	52"	107 <sup>1</sup> / <sub>8</sub> "	45"	75 <sup>3</sup> / <sub>4</sub> "	24"	24"	Guardians	\$4,239	4830
54" Gothic Full	53 <sup>3</sup> / <sub>4</sub> "	118 <sup>7</sup> / <sub>8</sub> "	46"	163 <sup>1</sup> / <sub>2</sub> "	24"	24"	Guardians	\$7,889	9154
54" Gothic Lower	53 <sup>3</sup> / <sub>4</sub> "	118 <sup>7</sup> / <sub>8</sub> "	46"	75 <sup>3</sup> / <sub>4</sub> "	24"	24"	Guardians	\$5,347	5878
Guardians Hearth	3 <sup>3</sup> / <sub>4</sub> "	-	99 <sup>3</sup> / <sub>4</sub> "	-	27"	-	-	\$289	860
Guardians Hearth	3 <sup>3</sup> / <sub>4</sub> "	-	117 <sup>1</sup> / <sub>2</sub> "	-	27"	-	-	\$289	942



# Guardians 39"™

A smaller Guardians, the same great look as the original, but designed to fit in smaller areas. Can be used with the Guardians hearth, or will fit on our standard and raised hearths.

*Note: the smaller dogs are not exactly the same as the larger ones. Refer to the photos for the smaller dogs.*



**Guardians 39" Lower Mantel**



**Guardians 39" Full Height**



Size	X	XX	Y	YY	Z	ZZ	Hearth	Cost	Weight
39" Full	39"	71"	33 <sup>1</sup> / <sub>4</sub> "	125 <sup>1</sup> / <sub>4</sub> "	13"	12 <sup>3</sup> / <sub>4</sub> "	70"	\$4,285	4190
39" Lower	39"	71"	33 <sup>1</sup> / <sub>4</sub> "	55 <sup>1</sup> / <sub>2</sub> "	13"	12 <sup>3</sup> / <sub>4</sub> "	70"	\$2,786	2543
Guardians Hearth	3 <sup>3</sup> / <sub>4</sub> "	-	70"	-	24"	-	-	\$279	473



*Bring the classical beauty of Imperial Rome into your home. This surround uses many of the classical elements from the fluted column legs to the dentil entablature.*



*At left is a close up of the Imperial pilaster cap.*

Size	X	XX	Y	YY	Z	ZZ	Hearth	Cost	Weight
42"	42"	110¼"	36"	65⅞"	13½"	9¾"	108"	\$1,560	2538

*The Imperial is inventoried in Standard Tan.*

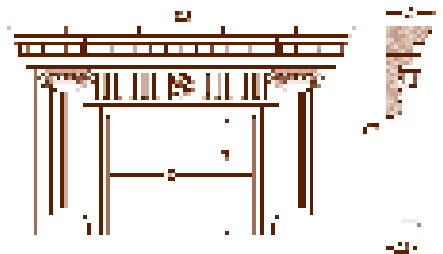

*For hearth information, please refer to page 73.*

*For crate information, please refer to page 76.*

**Major Credit Cards Accepted!**





*Leaf Tudor™*

# Leaf Tudor™

The Tudor arch recalls the London of Queen Elizabeth I – vibrant with Shakespearian plays, the Age of Exploration, and the most elegant court in all of Europe. Bring the romance home to your castle with the Leaf Tudor. Also available with plain corners.



At left, the Leaf Tudor without leaves is shown with an optional raised hearth.



The Leaf Tudor shown above and at right were installed with custom natural cut stone filler panels. Call for pricing.

Size	X	XX	Y	YY	Z	ZZ	Leg	Hearth	Cost	Weight
36"	35 <sup>7</sup> / <sub>8</sub> "	61 <sup>5</sup> / <sub>8</sub> "	37"	53 <sup>1</sup> / <sub>8</sub> "	8 <sup>1</sup> / <sub>8</sub> "	4 <sup>1</sup> / <sub>4</sub> "	28"	64 <sup>1</sup> / <sub>4</sub> "	\$1,000	804
42"	41 <sup>7</sup> / <sub>8</sub> "	67 <sup>5</sup> / <sub>8</sub> "	42"	58 <sup>3</sup> / <sub>8</sub> "	8 <sup>1</sup> / <sub>8</sub> "	4 <sup>1</sup> / <sub>4</sub> "	33 <sup>1</sup> / <sub>2</sub> "	70"	\$1,070	916
48"	47 <sup>7</sup> / <sub>8</sub> "	73 <sup>5</sup> / <sub>8</sub> "	45"	61 <sup>3</sup> / <sub>8</sub> "	8 <sup>1</sup> / <sub>8</sub> "	4 <sup>1</sup> / <sub>4</sub> "	36 <sup>1</sup> / <sub>4</sub> "	76 <sup>1</sup> / <sub>4</sub> "	\$1,140	1020

All three Leaf Tudor (with leaves only) sizes are inventoried in Standard Tan.

For hearth information, please refer to page 73.

For crate information, please refer to page 76.

Major Credit Cards Accepted!

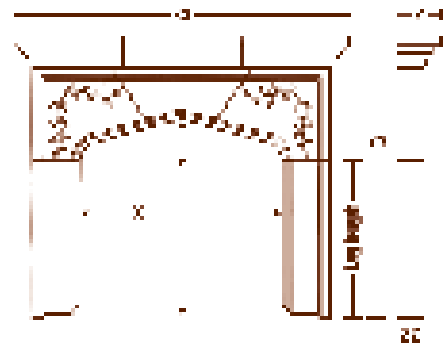



*Longleat*™



# Longleat™

Decorative, but functional, the Longleat can sound just the right note in your plans. And the Longleat is adjustable in opening width, making it even more appealing in many areas.

*The Longleat is easily adjusted in width. Below is a custom unit that substituted twisted columns for the standard legs.*



*The Longleat shown on the opposite page can be seen at our Galleria Pierra showroom in Dallas. Call 214-432-9999 for an appointment.*

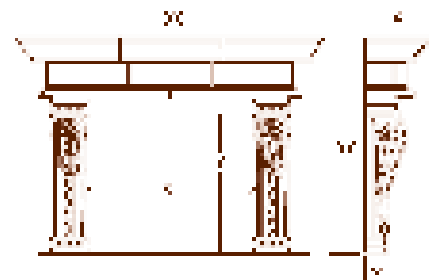
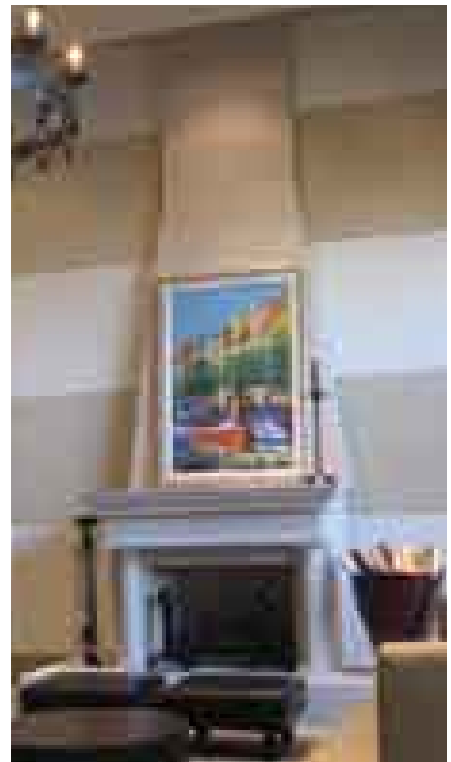

Size	X	XX	Y	YY	Z	ZZ	Hearth	Cost	Weight
44"	44"	78"	36 <sup>1</sup> / <sub>8</sub> "	56 <sup>7</sup> / <sub>8</sub> "	16"	5"	76 <sup>1</sup> / <sub>4</sub> "	\$2,237	2155

*Longleat is inventoried in Standard Tan.*

*For hearth information, please refer to page 73.*

*For crate information, please refer to page 76.*

**Major Credit Cards Accepted!**



*Louie*™



# Louie™

Named for the French kings whose eras have become synonymous with high style, the Louie brings a formal beauty to any room. Only possible with the craftsmanship of eras gone by, the Louie is truly a work of art.



*The formality of the Louie is often enhanced by using an interior surround of marble or granite as in the photo above and at far left.*

Size	X	XX	Y	YY	Z	ZZ	Hearth	Cost	Weight
40" Prince	40"	60½"	34½"	46"	10"	6"	66½"	\$1,799	668
40" King	40"	60½"	40"	51¼"	15½"	12"	66½"	\$2,150	1190
40" Emperor	40"	60½"	46⅛"	57"	15½"	12"	66½"	\$2,329	1450
48" Prince	48"	72"	40½"	51¾"	10"	6"	76¼"	\$2,249	925
48" King	48"	72"	40½"	51¾"	15½"	12"	76¼"	\$2,349	1250
54" Prince	54"	76"	34½"	45⅝"	10"	6"	76¼"	\$2,150	935
54" King	54"	76"	40"	50⅞"	15½"	12"	76¼"	\$2,450	1218
54" Emperor	54"	76"	46⅛"	57"	15½"	12"	76¼"	\$2,963	1650
68" Prince*	68"	90"	40"	51¾"	10"	6"	108"	\$2,550	1218
68" King*	68"	90"	40"	51¾"	15½"	12"	108"	\$2,649	1600
68" Emperor	68"	90"	46⅛"	57"	15½"	12"	108"	\$3,199	1978

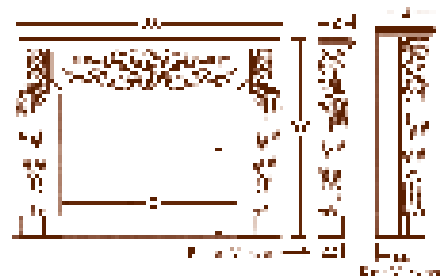

\*The 68" Louie is available with only the taller leg, whether a Prince or a King. However most Louie parts (except the 48") can be mixed and matched as needed.

*The Louie King and Prince in sizes 40", 48" and 54" are inventoried in Standard Tan. Other sizes are made to order.*



# Marquis™

The Marquis reflects the subdued classic French style. The shell (photo below) and the crest in the upper mantel are beautifully detailed.



**Marquis Full Height**

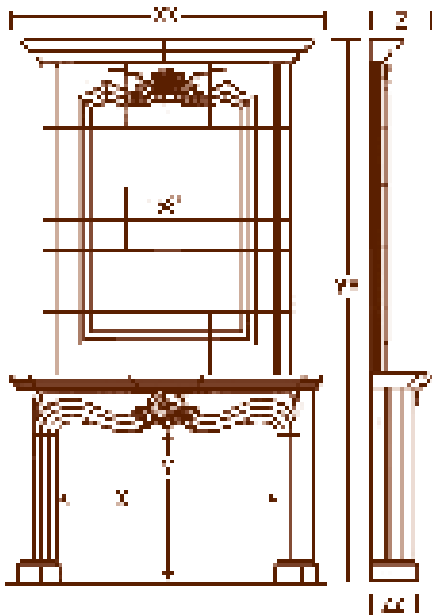

**Marquis Lower Mantel**

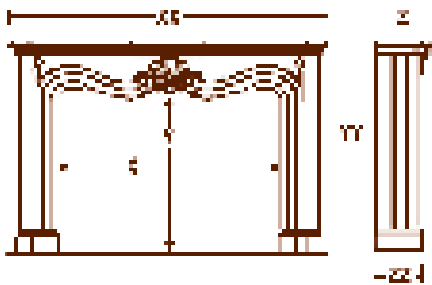

Size	X	XX	Y	YY	Z	ZZ	Hearth	Cost	Weight
Full	48"	68 <sup>1</sup> / <sub>4</sub> "	36"	120"	13 <sup>3</sup> / <sub>4</sub> "	10 <sup>3</sup> / <sub>4</sub> "	70"	\$3,744	2357
Lower	48"	68 <sup>1</sup> / <sub>4</sub> "	36"	46 <sup>1</sup> / <sub>4</sub> "	13 <sup>3</sup> / <sub>4</sub> "	10 <sup>3</sup> / <sub>4</sub> "	70"	\$1,924	1225

*The Marquis Lower Mantel, as shown in the drawing at left, is inventoried in Standard Tan color.*

**For hearth information, please refer to page 73.**

**For crate information, please refer to page 76.**

**Major Credit Cards Accepted!**



# Martine™

Specifically designed for small spaces, like bedrooms, the Martine combines grace with utility. The Martine is available in three widths and the legs can be cut to fit on site. No mantel cap is included with the Martine.



*Above is the Martine 42".*



*Above is the Martine customized*

Size	X	XX	Y	YY	Z	ZZ	Hearth	Cost	Weight
36"	36"	62"	36"	48"	5 <sup>3</sup> / <sub>4</sub> "	6 <sup>3</sup> / <sub>4</sub> "	66 <sup>1</sup> / <sub>2</sub> "	\$1,089	906
42"	42"	68"	36"	48"	5 <sup>3</sup> / <sub>4</sub> "	6 <sup>3</sup> / <sub>4</sub> "	70"	\$1,214	1035
48"	48"	74"	36"	48"	5 <sup>3</sup> / <sub>4</sub> "	6 <sup>3</sup> / <sub>4</sub> "	76 <sup>1</sup> / <sub>4</sub> "	\$1,339	1166

*The Martine 36" and 42" are inventoried in Standard Tan color.*

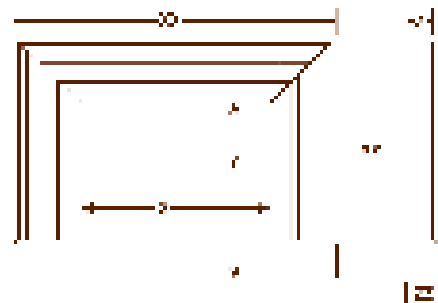

**For hearth information, please refer to page 73.**

**For crate information, please refer to page 76.**

**Major Credit Cards Accepted!**



*Polo*™





The Polo is a timeless design. It will become the center of many treasured conversations with family and friends gathered around the warmth of the fire.



The Polo above was installed with an optional flat hearth.

Left is a Polo 36" with slightly longer than normal legs to accommodate a taller firebox.

Size	X	XX	Y	YY	Z	ZZ	Leg	Hearth	Cost	Weight
36"	35 <sup>1</sup> / <sub>2</sub> "	64 <sup>1</sup> / <sub>2</sub> "	35 <sup>3</sup> / <sub>4</sub> "	53 <sup>7</sup> / <sub>8</sub> "	10 <sup>1</sup> / <sub>2</sub> "	6 <sup>1</sup> / <sub>2</sub> "	25 <sup>3</sup> / <sub>4</sub> "	66 <sup>1</sup> / <sub>2</sub> "	\$1,175	1210
42"	41 <sup>7</sup> / <sub>8</sub> "	69 <sup>7</sup> / <sub>8</sub> "	42"	58 <sup>7</sup> / <sub>8</sub> "	10 <sup>1</sup> / <sub>2</sub> "	6 <sup>1</sup> / <sub>2</sub> "	30 <sup>3</sup> / <sub>4</sub> "	70"	\$1,225	1305
48"	47 <sup>1</sup> / <sub>2</sub> "	75 <sup>1</sup> / <sub>2</sub> "	48"	64 <sup>1</sup> / <sub>8</sub> "	10 <sup>1</sup> / <sub>2</sub> "	6 <sup>1</sup> / <sub>2</sub> "	36"	76 <sup>1</sup> / <sub>4</sub> "	\$1,275	1426

All three Polo sizes are inventoried in Standard Tan.

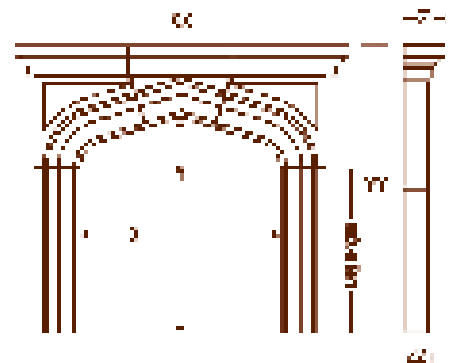

For hearth information, please refer to page 73.

For crate information, please refer to page 76.

**Major Credit Cards Accepted!**





*Provence*™



# Provence™ 40", 42" & 48"



Above is a 42" Provence Petite shown with the Provence Upper Mantel and flat hearth.



Above is a 48" Lower Provence with an optional raised hearth.

Inspired by the sunny south of France, where families gathered in comfort to share cherished memories, The Provence echoes the easy informality of country French living.



Above is a Provence Lower in coral stone finish, available at an additional charge on any of our surrounds.

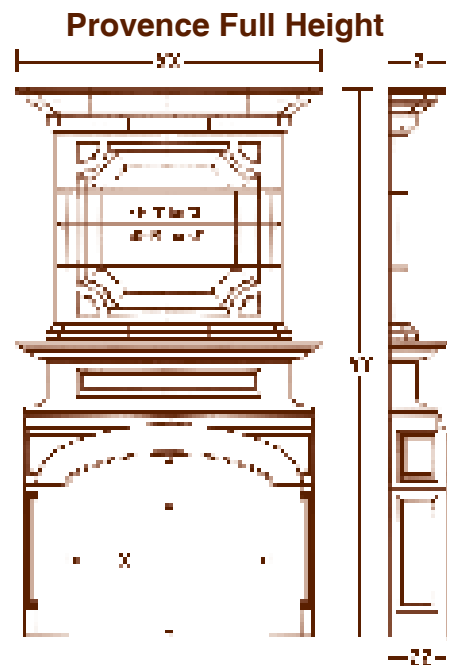
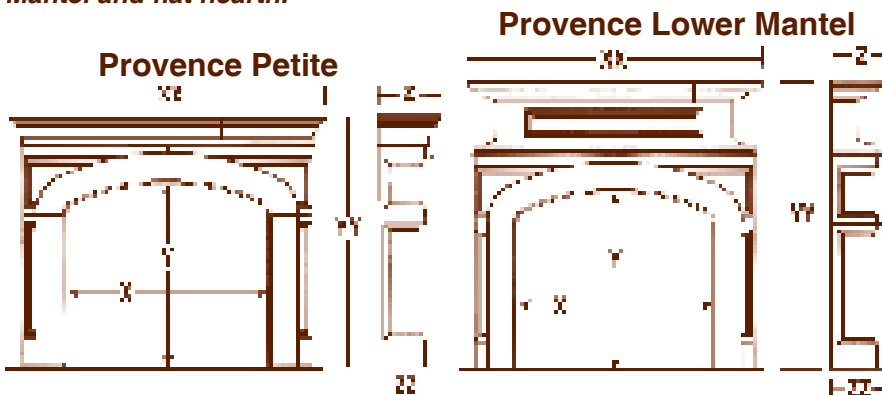

Size	X	XX	Y	YY	Z	ZZ	Hearth	Cost	Weight
40" Full	40"	58½"	39"	120"	12¼"	12"	60"	\$4,299	2715
40" Lower	40"	58½"	39"	65⅝"	12¼"	12"	60"	\$2,699	1695
40" Petite	40"	62½"	39"	54⅝"	14"	12"	60"	\$2,499	1590
42" Full	42⅛"	64"	40"	120"	12¼"	12"	66½"	\$4,400	2815
42" Lower	42⅛"	64"	40"	65⅝"	12¼"	12"	66½"	\$2,800	1765
42" Petite	42⅛"	68"	40"	54⅝"	14"	12"	66½"	\$2,600	1610
48" Full	48"	70"	40"	144"	12¼"	12"	70"	\$4,990	3970
48" Lower	48"	70"	40"	65⅝"	12¼"	12"	70"	\$3,093	1975
48" Petite	48"	74"	40"	54⅝"	14"	12"	70"	\$2,763	1723

Most of the Provence sizes on this page are inventoried in Standard Tan. The exceptions are the 40" Provence Lower and Full Height, and the 48" Full Height.



*Provence*™



# Provence™ 54" & 65"



Provence Petite 54"

A wider Provence to fit additional firebox openings.

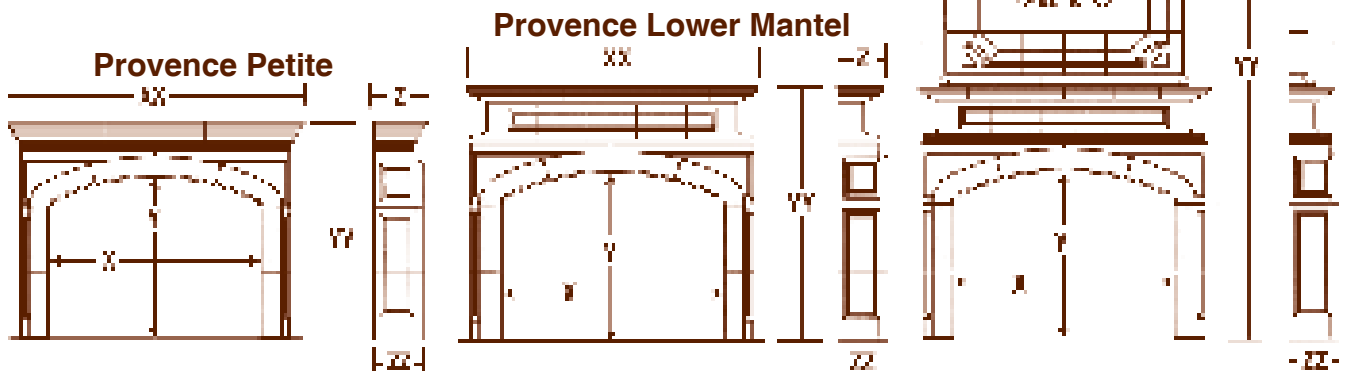

Size	X	XX	Y	YY	Z	ZZ	Hearth	Cost	Weight
54" Full	54 <sup>1</sup> / <sub>8</sub> "	76"	40"	144"	12 <sup>1</sup> / <sub>4</sub> "	12"	76 <sup>1</sup> / <sub>4</sub> "	\$5,195	3560
54" Lower	54 <sup>1</sup> / <sub>8</sub> "	76"	40"	65 <sup>5</sup> / <sub>8</sub> "	12 <sup>1</sup> / <sub>4</sub> "	12"	76 <sup>1</sup> / <sub>4</sub> "	\$3,299	2418
54" Petite	54 <sup>1</sup> / <sub>8</sub> "	80"	40"	54 <sup>5</sup> / <sub>8</sub> "	14"	12"	76 <sup>1</sup> / <sub>4</sub> "	\$2,993	1740
65" Full	65"	87"	50"	160"	12 <sup>1</sup> / <sub>4</sub> "	12"	87"	\$5,400	4030
65" Lower	65"	87"	50"	75 <sup>3</sup> / <sub>4</sub> "	12 <sup>1</sup> / <sub>4</sub> "	12"	87"	\$3,400	2648
65" Petite	65"	91"	50"	64 <sup>3</sup> / <sub>4</sub> "	14"	12"	87"	\$3,200	2036

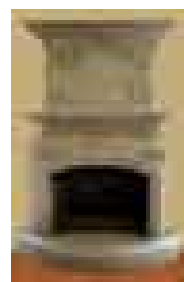

Shown left is a customized Full Height Provence 48" with the Grand Baroque radius raised hearth.



The Provence Lower 65" and Provence Petite 54" and 65" sizes are inventoried in Standard Tan.

*Regency*™



# Regency™



Named for one of the more colorful periods of English history, the Regency combines deeply fluted legs with a carved ornament as an accent.



Above is a Regency 48" with a customized Fleet upper mantel. See our standard Upper Mantels.

Size	X	XX	Y	YY	Z	ZZ	Hearth	Cost	Weight
36"	36"	72 <sup>1</sup> / <sub>2</sub> "	36 <sup>1</sup> / <sub>4</sub> "	54 <sup>3</sup> / <sub>8</sub> "	10 <sup>1</sup> / <sub>2</sub> "	5"	70"	\$1,349	1270
42"	42"	78 <sup>1</sup> / <sub>2</sub> "	36 <sup>1</sup> / <sub>4</sub> "	54 <sup>3</sup> / <sub>8</sub> "	10 <sup>1</sup> / <sub>2</sub> "	5"	76 <sup>1</sup> / <sub>4</sub> "	\$1,449	1400
48"	48"	84"	36 <sup>1</sup> / <sub>4</sub> "	54 <sup>3</sup> / <sub>8</sub> "	10 <sup>1</sup> / <sub>2</sub> "	5"	80"	\$1,549	1426

All three Regency sizes are inventoried in Standard Tan.

For hearth information, please refer to page 73.

For crate information, please refer to page 76.

**Major Credit Cards Accepted!**



*Windsor™*





Photo above is a 48" Windsor with optional raised hearth.

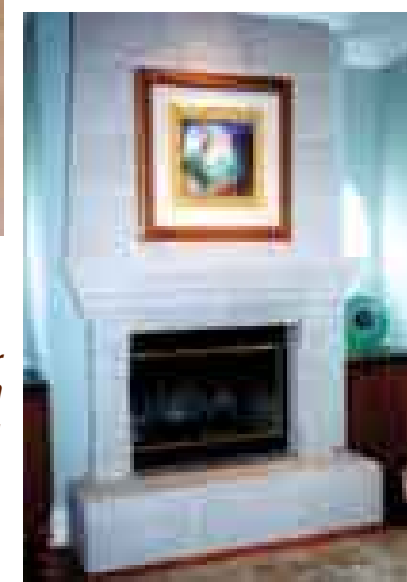

Photo at right is a 42" Windsor with optional raised hearth and Fleet Upper Mantel.

The 48" and 60" sizes use a plinth block to raise the height to that shown in the chart. Plinth is not shown on the generic drawing.

Size	X	XX	Y	YY	Z	ZZ	Hearth	Cost	Weight
36"	36"	64 <sup>1</sup> / <sub>4</sub> "	32 <sup>1</sup> / <sub>2</sub> "	48 <sup>1</sup> / <sub>2</sub> "	12 <sup>5</sup> / <sub>8</sub> "	6"	64 <sup>1</sup> / <sub>4</sub> "	\$1,540	1263
42"	42"	70 <sup>1</sup> / <sub>4</sub> "	32 <sup>1</sup> / <sub>2</sub> "	48 <sup>1</sup> / <sub>2</sub> "	12 <sup>5</sup> / <sub>8</sub> "	6"	70"	\$1,590	1335
48"	48"	76 <sup>1</sup> / <sub>4</sub> "	37"	52 <sup>1</sup> / <sub>2</sub> "	12 <sup>5</sup> / <sub>8</sub> "	6 <sup>3</sup> / <sub>4</sub> "	76 <sup>1</sup> / <sub>4</sub> "	\$1,690	1420
60"	60"	88"	37"	52 <sup>1</sup> / <sub>2</sub> "	12 <sup>5</sup> / <sub>8</sub> "	6 <sup>3</sup> / <sub>4</sub> "	90"	\$2,215	1775

All four Windsor sizes are inventoried in Standard Tan.

For hearth information, please refer to page 73.

For crate information, please refer to page 76.

Major Credit Cards Accepted!

# Windsor™

Formal to casual, the Windsor is timeless and can work in any decor. Families will fondly recall the Windsor as a gathering place for generations to come. Our most versatile surround, the Windsor can be made in any width from 36" to 72". And, the legs can be made taller to accommodate a taller opening. Send us your specifications for a quote.

Windsor below is shown with the Summerville Upper Mantel. Unit has been faux-painted.

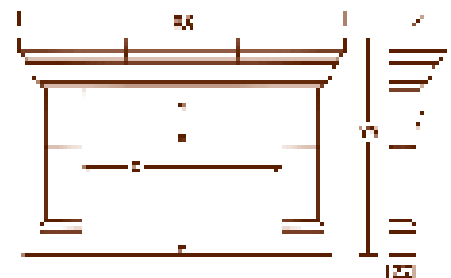

# Alameda™

Simple and elegant the Alameda has a strong Mediterrean influence



Premiere Collection

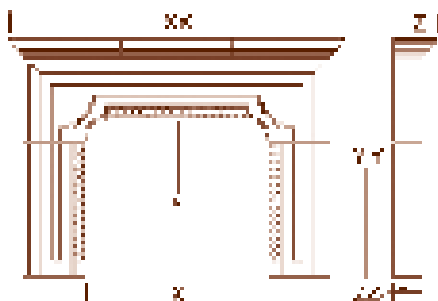

Size	X	XX	Y	YY	Z	ZZ	Hearth	Cost	Weight
42"	42"	76"	36"	54 <sup>1</sup> / <sub>4</sub> "	10"	6 <sup>1</sup> / <sub>2</sub> "	80"	\$1,139	1165



# Alhambra™

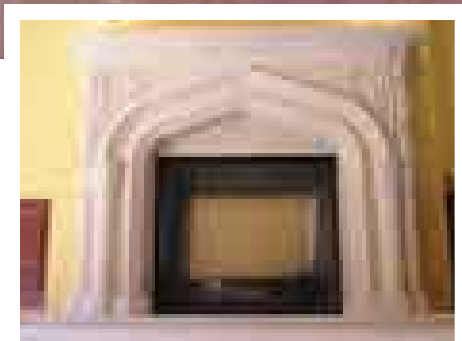

The Alhambra reflects a unique mediterranean style with exquisite detail. An elegant addition to any room.

Size	X	XX	Y	YY	Z	ZZ	Hearth	Cost	Weight
48"	48"	87"	48"	66"	12 <sup>1</sup> / <sub>4</sub> "	10 <sup>3</sup> / <sub>4</sub> "	90"	\$1,935	2150

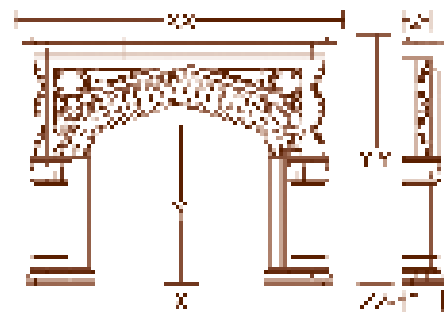

*For hearth information, please refer to page 73.*

*For crate information, please refer to page 76.*

**Major Credit Cards Accepted!**



# Anton™

Unique is the only word for the Anton. The arched opening of the fireplace is echoed in the arch at the top of the upper mantel. One of our newest designs.



Anton Full Height

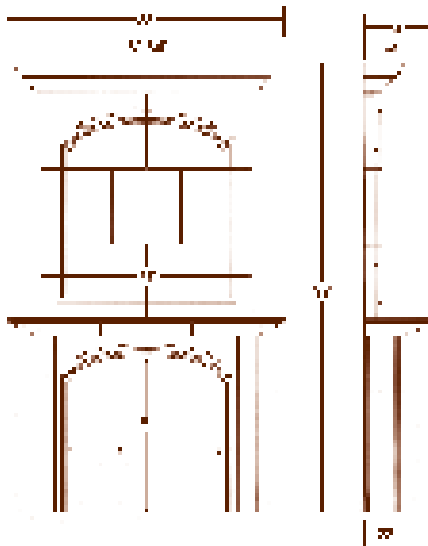

Anton Lower Mantel

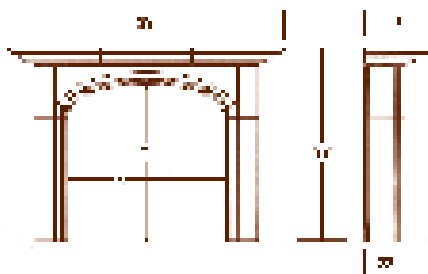

Size	X	XX	Y	YY	Z	ZZ	Hearth	Cost	Weight
42" Full	42"	72 <sup>3</sup> / <sub>4</sub> "	42"	120"	17 <sup>3</sup> / <sub>4</sub> "	11"	76 <sup>1</sup> / <sub>4</sub> "	\$3,901	4015
42" Lower	42"	72 <sup>3</sup> / <sub>4</sub> "	42"	51 <sup>3</sup> / <sub>4</sub> "	17 <sup>3</sup> / <sub>4</sub> "	11"	76 <sup>1</sup> / <sub>4</sub> "	\$2,010	2210

*For hearth information, please refer to page 73.*

*For crate information, please refer to page 76.*

**Major Credit Cards Accepted!**





# Aspen™

The rustic styling of the Aspen helps create a warm atmosphere unspoiled by the outside world. Sit back, relax and escape life's little pressures.

**Aspen Mantel Cap**



**Aspen Surround**



**Aspen Raised Hearth**



Size	X	XX	Y	YY	Z	ZZ	Hearth	Cost	Weight
42"	42"	63 <sup>1</sup> / <sub>4</sub> "	32"	44 <sup>3</sup> / <sub>4</sub> "	5"	5"	76 <sup>1</sup> / <sub>4</sub> "	\$619	680
48"	48"	69 <sup>1</sup> / <sub>4</sub> "	36"	48 <sup>3</sup> / <sub>4</sub> "	5"	5"	76 <sup>1</sup> / <sub>4</sub> "	\$693	770
Mantel Cap	5"	-	74"	-	12"	-	-	\$250	383
Raised Hearth	15"	-	76"	-	20"	-	-	\$450	690

*For hearth information, please refer to page 73.*

*For crate information, please refer to page 76.*

**Major Credit Cards Accepted!**



# Brittany™

*D*rama with a distinctly French twist, the Brittany brings with it the feel of ancient France, songs of glory and knights jousting.



**Brittany Hearth**



**Brittany Lower Mantel**

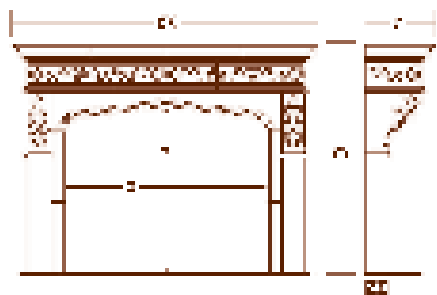

**Brittany Full Height 48"**



**Brittany Full Height 72"**

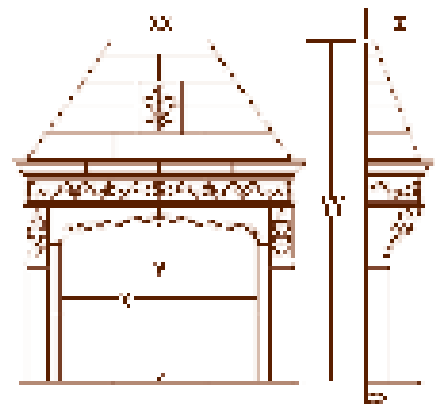

Size	X	XX	Y	YY	Z	ZZ	Hearth	Cost	Weight
48" Full	48"	85"	44"	120"	25"	9"	87"	\$4,541	6079
48" Lower	48"	85"	44"	68 <sup>11</sup> / <sub>16</sub> "	25"	9"	87"	\$3,339	3651
72" Full	72 <sup>1</sup> / <sub>2</sub> "	109"	62 <sup>3</sup> / <sub>4</sub> "	132"	25"	8"	108"	\$6,728	8500
72" Lower	72 <sup>1</sup> / <sub>2</sub> "	109"	62 <sup>3</sup> / <sub>4</sub> "	85 <sup>1</sup> / <sub>2</sub> "	25"	8"	108"	\$5,043	5996
Brittany Hearth	3"	-	105"	-	20"	-	-	\$350	473

*For hearth information, please refer to page 73.*

*For crate information, please refer to page 76.*

**Major Credit Cards Accepted!**



# Cambridge™



A strong characteristic of the Cambridge is it's columns. This fireplace will be the focal point in any room it is featured in.

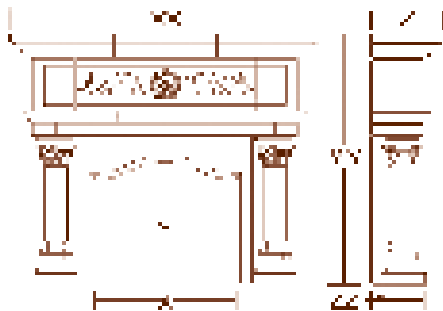

Size	X	XX	Y	YY	Z	ZZ	Hearth	Cost	Weight
48"	48"	107"	42"	86"	25½"	18½"	108"	\$4,129	4859

*For hearth information, please refer to page 73.*

*For crate information, please refer to page 76.*

**Major Credit Cards Accepted!**



# Grand Baroque™

The Grand Baroque was designed to make an impression in a large room.

The Full Height Grand Baroque comes with an upper mantel that includes mirror surround. *The mirror is not included.* Stone to fill the mirror surround is also available.

The Lower Grand Baroque makes a nice addition to any room.



The photo, right, is a Grand Baroque installed showing the angled side pieces of the upper mantel and the radius on the hearth.

Grand Baroque Full Height

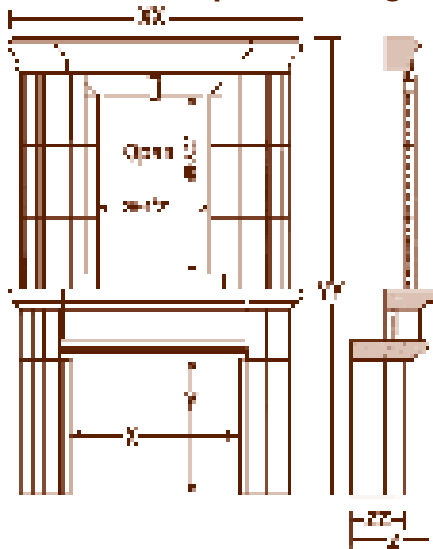

Lower Grand Baroque

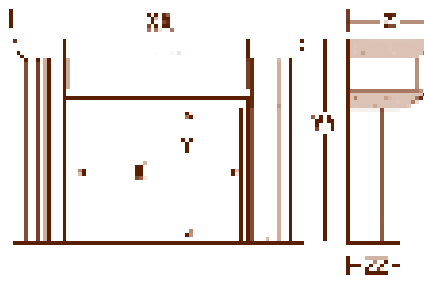

Lower Grand Baroque Mantel Plan

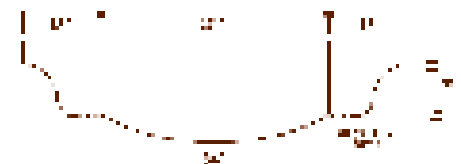

Size	X	XX	Y	YY	Z	ZZ	Hearth	Cost	Weight
42" Full Height	42"	84"	36"	121½"	23¼"	13⅝"	87"	\$4,779	4275
42" Lower Mantel	42"	84"	36"	55¾"	23¼"	13⅝"	87"	\$3,649	2646
Mirror Filler	27"	-	46¼"	-	4"	-	-	\$349	693
Radius Hearth	2"	-	82"	-	26¾"	-	-	\$300	497
Raised Hearth	15"	-	82"	-	26¾"	-	-	\$650	850

Optional Radius Hearth  
Plan View and Profile

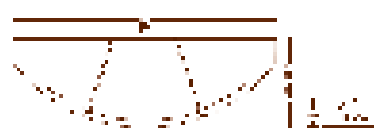

For hearth information, please refer to page 73.

For crate information, please refer to page 76.

Major Credit Cards Accepted!



Premiere Collection

*Drawn with classically straight lines, the Columbia is austereally beautiful.*

**Columbia Full Height**

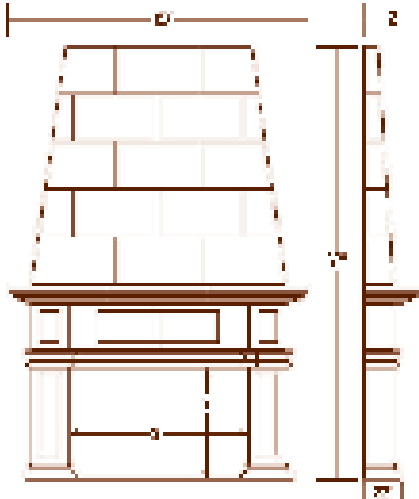

**Columbia Lower Mantel**

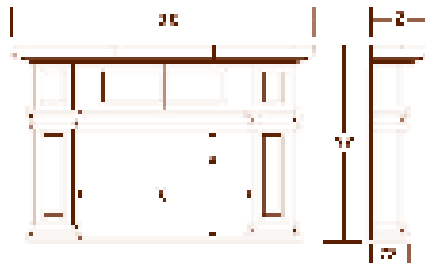

Size	X	XX	Y	YY	Z	ZZ	Hearth	Cost	Weight
48" Full	48"	80"	30 <sup>3</sup> / <sub>4</sub> "	120"	15 <sup>3</sup> / <sub>4</sub> "	9 <sup>3</sup> / <sub>4</sub> "	80"	\$4,989	4573
48" Lower	48"	80"	30 <sup>3</sup> / <sub>4</sub> "	53 <sup>3</sup> / <sub>4</sub> "	15 <sup>3</sup> / <sub>4</sub> "	9 <sup>3</sup> / <sub>4</sub> "	80"	\$2,993	2744

*For hearth information, please refer to page 73.*

*For crate information, please refer to page 76.*

**Major Credit Cards Accepted!**



# Devonshire™

Premiere Collection



Reflecting a gracious period in the history of the traditional English Country House, the Devonshire will become the center of any room.

Size	X	XX	Y	YY	Z	ZZ	Hearth	Cost	Weight
42"	42"	94½"	36"	66"	10¾"	8½"	108"	\$1,750	1825

*For hearth information, please refer to page 73.*

*For crate information, please refer to page 76.*

**Major Credit Cards Accepted!**

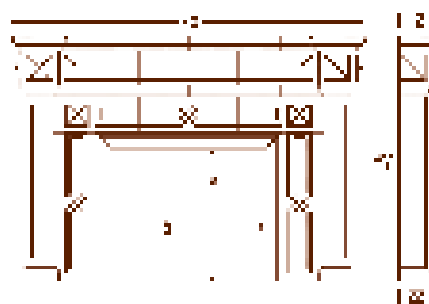



# DiConte™



Small rooms need not be a handicap. The DiConte is designed to fit comfortably in a master suite, or even in the master bath. Steel lintel (*not included*) required for center support.

Premiere Collection

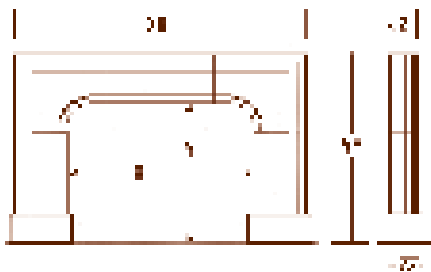

Size	X	XX	Y	YY	Z	ZZ	Hearth	Cost	Weight
42"	42"	68"	30 <sup>7</sup> / <sub>8</sub> "	41 <sup>3</sup> / <sub>4</sub> "	6"	7"	70"	\$895	957

*For hearth information, please refer to page 73.*  
*For crate information, please refer to page 76.*

**Major Credit Cards Accepted!**



# Emporium™

Named for the greatest market place in the Roman Empire, the Emporium is a blend of classical elements and decoration. The beauty and grace will enhance a formal living room or great room.



Premiere Collection

Size	X	XX	Y	YY	Z	ZZ	Hearth	Cost	Weight
48"	48"	74 <sup>1</sup> / <sub>4</sub> "	43"	63 <sup>1</sup> / <sub>4</sub> "	10 <sup>3</sup> / <sub>8</sub> "	6 <sup>3</sup> / <sub>4</sub> "	70"	\$2,330	1788

*For hearth information, please refer to page 73.*

*For crate information, please refer to page 76.*

**Major Credit Cards Accepted!**



# Fenwick™

*T*wisted columns, similar to the ones from the Falkland, give the Fenwick a festive look. Add an elegantly simple mantel cap and interior surround and you have a beautiful addition to any room.



*Left, the before shot of the Fenwick installation shown below.*

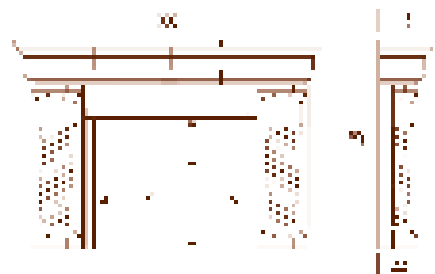

Size	X	XX	Y	YY	Z	ZZ	Hearth	Cost	Weight
42"	42"	89 <sup>1</sup> / <sub>4</sub> "	38"	60"	16 <sup>7</sup> / <sub>8</sub> "	11 <sup>3</sup> / <sub>4</sub> "	90"	\$2,687	3521

*For hearth information, please refer to page 73.*

*For crate information, please refer to page 76.*

**Major Credit Cards Accepted!**



# Hamilton™

Modern design teams with ageless execution to present the Hamilton.



Above is a wider, square version of the Hamilton.



Size	X	XX	Y	YY	Z	ZZ	Hearth	Cost	Weight
48"	48½"	87½"	56"	84"	25½"	13½"	80"	\$3,579	3976
60"	60"	99"	56"	84"	25½"	13½"	90"	\$4,117	4573

*For hearth information, please refer to page 73.*  
*For crate information, please refer to page 76.*

**Major Credit Cards Accepted!**

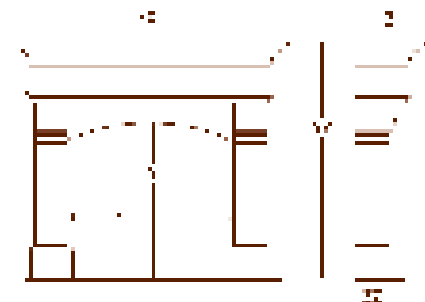

The Jocelyn features graceful curves that will sweep anybody off their feet with its grandeur and beauty.



Premiere Collection

Size	X	XX	Y	YY	Z	ZZ	Hearth	Cost	Weight
48"	48"	125½"	36"	54"	24"	13¼"	120"	\$4,562	5367

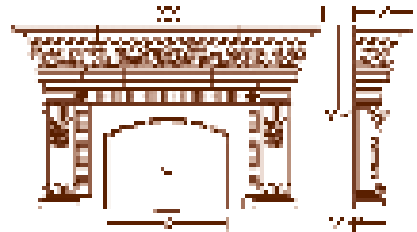

*For hearth information, please refer to page 73.*  
*For crate information, please refer to page 76.*

**Major Credit Cards Accepted!**



# Medallion™



*F*ederalist in tone, the Medallion uses fluted legs and an ornamented undermantel to bring this era in United States history to your home.

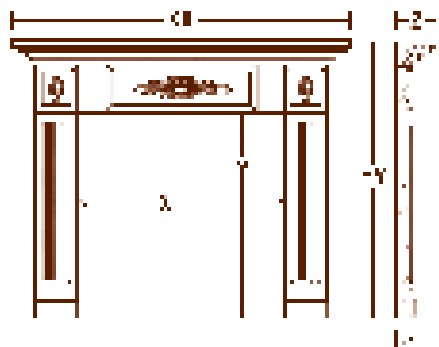

Size	X	XX	Y	YY	Z	ZZ	Hearth	Cost	Weight
36"	36"	59 <sup>3</sup> / <sub>16</sub> "	34 <sup>3</sup> / <sub>4</sub> "	47"	7 <sup>1</sup> / <sub>16</sub> "	3 <sup>1</sup> / <sub>2</sub> "	57 <sup>1</sup> / <sub>2</sub> "	\$890	591



*For hearth information, please refer to page 73.*  
*For crate information, please refer to page 76.*

**Major Credit Cards Accepted!**



*D*ecidedly Scandinavian in inspiration, the Nordic offers a unique look. The Nordic includes flatface fillers to make a firebox 36" wide and up to 28" tall. These can be cut to fit your firebox on site. Maximum size is 54" wide by 48" tall, with no fillers.

Size	X	XX	Y	YY	Z	ZZ	Hearth	Cost	Weight
36"	36"	80"	28"	66"	23"	10"	80"	\$2,875	3136

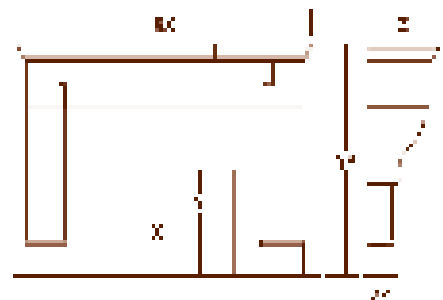

*For hearth information, please refer to page 73.*

*For crate information, please refer to page 76.*

**Major Credit Cards Accepted!**



# Normandie™

Country French in feel, the Normandie is unique with the reflected ellipses in the mantel and overmantel.



Premiere Collection

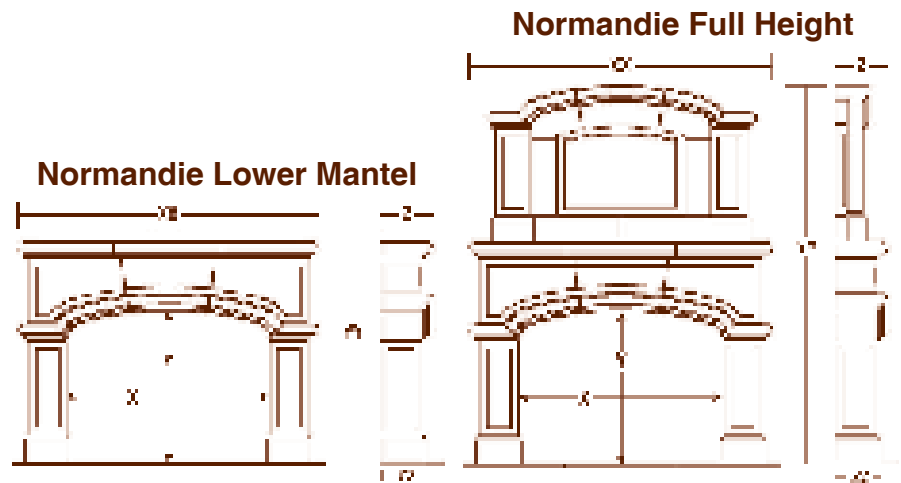

Size	X	XX	Y	YY	Z	ZZ	Hearth	Cost	Weight
58" Full	58"	86"	45 <sup>1</sup> / <sub>4</sub> "	111 <sup>3</sup> / <sub>4</sub> "	15"	13"	87"	\$5,908	5763
58" Lower	58"	86"	45 <sup>1</sup> / <sub>4</sub> "	65 <sup>1</sup> / <sub>2</sub> "	15"	13"	87"	\$3,748	3748

*For hearth information, please refer to page 73.*

*For crate information, please refer to page 76.*

**Major Credit Cards Accepted!**





# Palatine™

A fireplace with style fit for the Romans. The Palatine is a combination of columns and classic artistry.

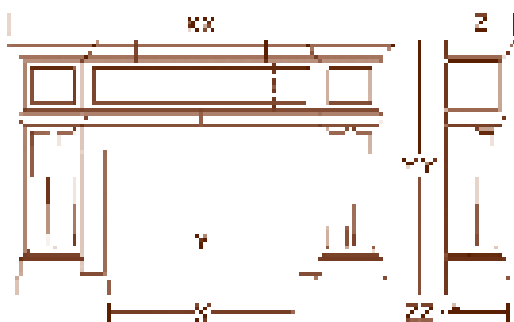

Size	X	XX	Y	YY	Z	ZZ	Hearth	Cost	Weight
48" w/Stone	48"	96"	36"	63"	17"	15½"	108"	\$2,754	3240
48" w/Bronze	48"	96"	36"	63"	17"	15½"	108"	\$4,454	3240

The Palatine, shown above, can be seen in person by visiting the new Galleria Pierra showroom in Dallas. Call 214-432-9999 for an appointment to tour the showroom.

For hearth information, please refer to page 73.

For crate information, please refer to page 76.

**Major Credit Cards Accepted!**



# Radcliffe™

Wild roses inspired the mantel decoration of this graceful surround.



**Radcliffe Full Height**

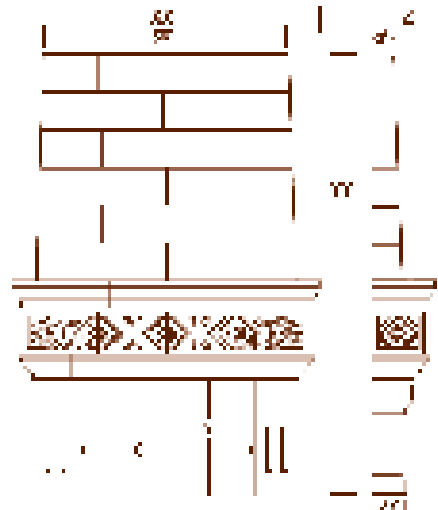

**Radcliffe Lower Mantel**

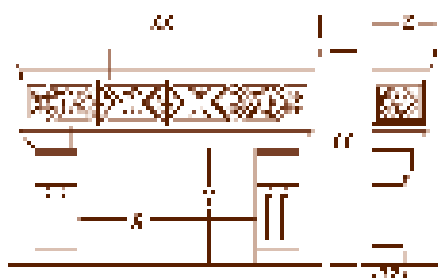

Size	X	XX	Y	YY	Z	ZZ	Hearth	Cost	Weight
42" Full	42"	76"	39"	118"	16 <sup>3</sup> / <sub>8</sub> "	7 <sup>3</sup> / <sub>8</sub> "	80"	\$6,559	3239
42" Lower	42"	76"	39"	63 <sup>1</sup> / <sub>2</sub> "	16 <sup>3</sup> / <sub>8</sub> "	7 <sup>3</sup> / <sub>8</sub> "	80"	\$4,679	2400

*For hearth information, please refer to page 73.*

*For crate information, please refer to page 76.*

**Major Credit Cards Accepted!**



# Richmond™



*E*legance in every line defines the Richmond. Steel lintel (*not included*) required to support center. Marble or cast stone fillers can be used to finish the overall look. (*Upper mantel shown not included.*)



Premiere Collection

Size	X	XX	Y	YY	Z	ZZ	Hearth	Cost	Weight
48"	48"	73"	40"	56¼"	21"	6"	66½"	\$2,988	1977

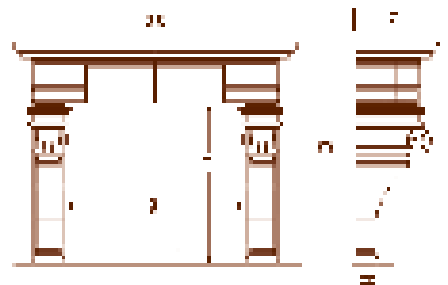

*For hearth information, please refer to page 73.*  
*For crate information, please refer to page 76.*

**Major Credit Cards Accepted!**



# Rochelle™

Uniquely twisted legs make the Rochelle a dramatic addition to any room.



Premiere Collection

Size	X	XX	Y	YY	Z	ZZ	Hearth	Cost	Weight
42"	42"	78"	39"	61"	21 <sup>1</sup> / <sub>4</sub> "	13 <sup>1</sup> / <sub>4</sub> "	80"	\$3,899	2170

*For hearth information, please refer to page 73.*

*For crate information, please refer to page 76.*

**Major Credit Cards Accepted!**

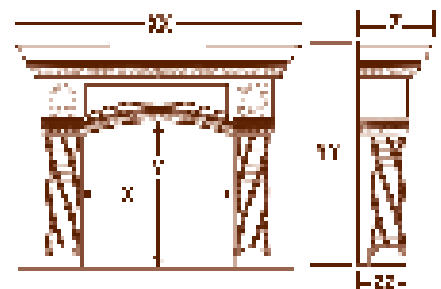

# Scarborough™

The Scarborough has everything, including an area to stack wood for your roaring fire. The wood pile is never far away on a cold winter night. You and your best friend can stay warm and cozy by the fire. Steel lintel (*not included*) required to support center.



Scarborough Hearth



## Scarborough Full Height

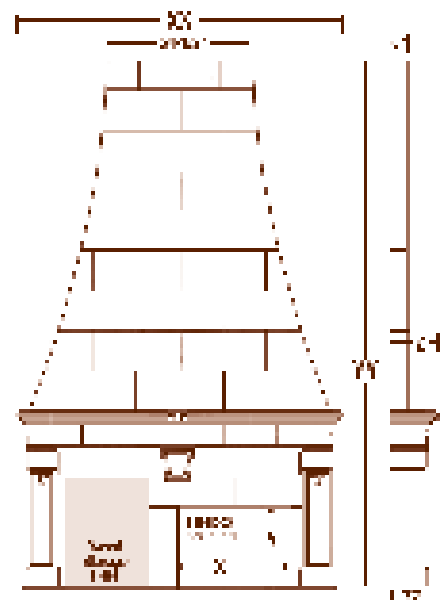

## Scarborough Lower Mantel

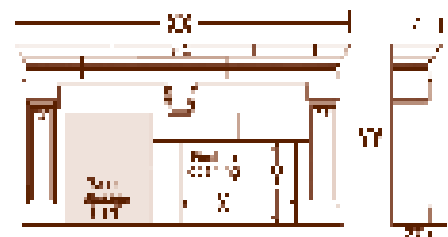

Size	X	XX	Y	YY	Z	ZZ	Hearth	Cost	Weight
46" Full	46 <sup>3</sup> / <sub>4</sub> "	136 <sup>1</sup> / <sub>2</sub> "	32 <sup>1</sup> / <sub>4</sub> "	236 <sup>5</sup> / <sub>8</sub> "	16"	12"	134"	\$8,475	12,375
46" Lower	46 <sup>3</sup> / <sub>4</sub> "	136 <sup>1</sup> / <sub>2</sub> "	32 <sup>1</sup> / <sub>4</sub> "	76"	16"	12"	134"	\$4,350	6030
Scarborough Hearth	3 <sup>3</sup> / <sub>4</sub> "	-	133 <sup>1</sup> / <sub>2</sub> "	-	24	-	-	\$450	1008

*For hearth information, please refer to page 73.*

*For crate information, please refer to page 76.*

**Major Credit Cards Accepted!**



# Scarsdale™

Based on the Scarborough, the Scarsdale fits a smaller area. Steel lintel (*not included*) required. The full height Scarsdale includes a graceful, double curved upper mantel that features a unique egg and dart profile.



**Scarsdale Full Height**

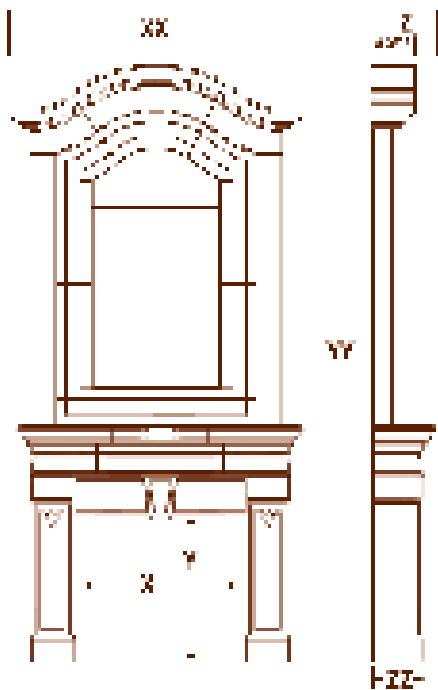

**Scarsdale Lower Mantel**

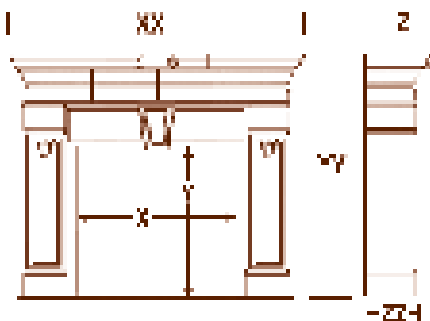

Size	X	XX	Y	YY	Z	ZZ	Hearth	Cost	Weight
48" Full	48"	87"	49"	188"	16"	12"	87"	\$6,500	6660
48" Lower	48"	87"	49"	76"	16"	12"	87"	\$3,250	3532
48" Full Short	48"	87"	31"	170"	16"	12"	87"	\$6,500	6360
48" Lower Short	48"	87"	31"	58"	16"	12"	87"	\$3,250	3495
Scarsdale Hearth	3 <sup>3</sup> / <sub>4</sub> "	-	90"	-	24	-	-	\$450	698

**Scarsdale Hearth**



*For hearth information, please refer to page 73.*

*For crate information, please refer to page 76.*

**Major Credit Cards Accepted!**



# Somerset™

One of our most impressive fireplaces, the Somerset is designed for oversized rooms. The upper mantel height can be customized to fit your specifications. Now we have added a U-shaped version that will cover a fireplace that extends into the room: the Somerset Grande.



## Somerset Full Height

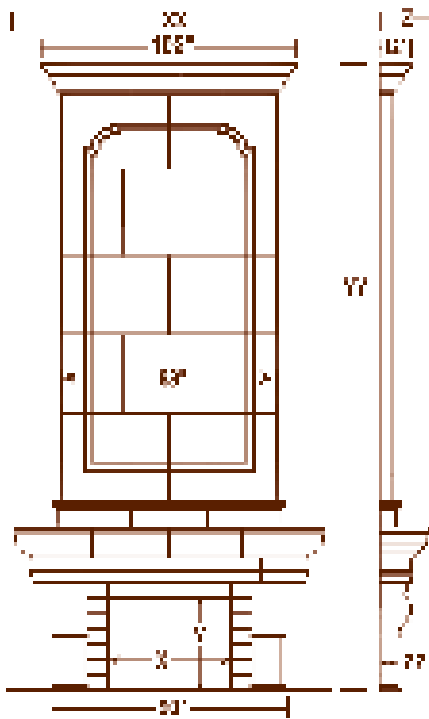

## Somerset Grande

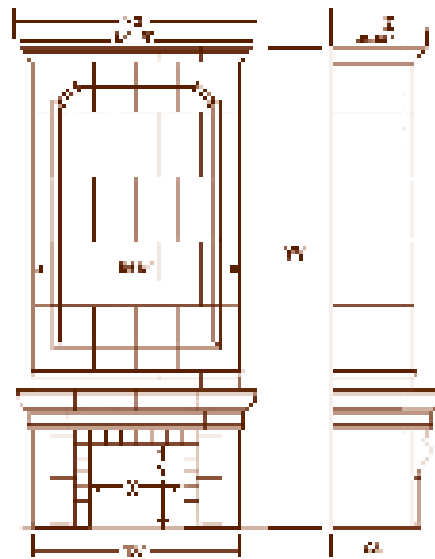

## Somerset Grande Plan View

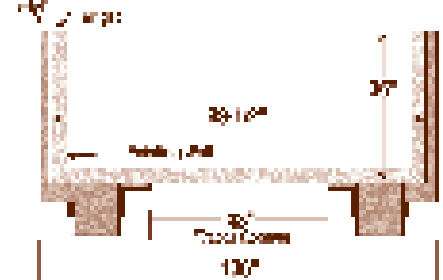

## Somerset Lower Mantel

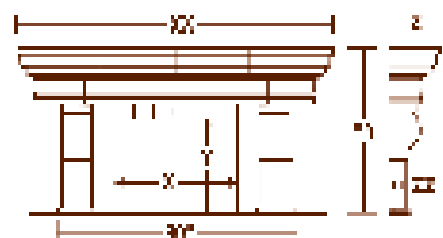

Size	X	XX	Y	YY	Z	ZZ	Hearth	Cost	Weight
48" Grande	48"	124"	45 1/2"	258"	57 1/2"	45 1/4"	120"	\$10,979	17,900
48" Full	48"	124"	45 1/2"	258"	21"	9"	120"	\$7,900	11,495
48" Lower	48"	124"	45 1/2"	74 1/4"	21"	9"	120"	\$3,400	5030

*For hearth information, please refer to page 73.*

*For crate information, please refer to page 76.*

**Major Credit Cards Accepted!**



# Venice™



*D*eeply fluted legs with an acanthus leaf motif carry a dramatic mantel cap that includes flower medallions.

Premiere Collection

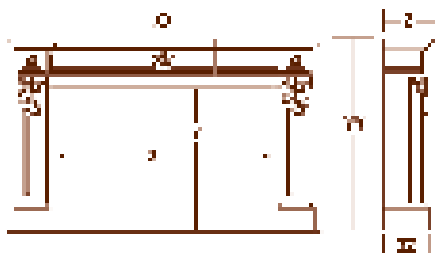

Size	X	XX	Y	YY	Z	ZZ	Hearth	Cost	Weight
54"	54"	80"	38 <sup>1</sup> / <sub>8</sub> "	52 <sup>1</sup> / <sub>8</sub> "	13"	12"	80"	\$2,299	1440



*For hearth information, please refer to page 73.*

*For crate information, please refer to page 76.*

**Major Credit Cards Accepted!**





A heavier, more massive Windsor, the Weldon will work with almost any decor. Like the Windsor, it is easily adjustable and can be made in many sizes. However, it is not recommended for a firebox width of less than 48" due to the size of the stones.

Size	X	XX	Y	YY	Z	ZZ	Hearth	Cost	Weight
48"	48"	82½"	47"	65½"	14"	10"	76¼"	\$2,197	2157
60"	60"	94½"	47"	65½"	14"	10"	90"	\$2,879	2368

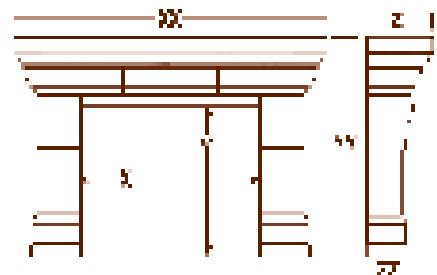

*For hearth information, please refer to page 73.*

*For crate information, please refer to page 76.*

**Major Credit Cards Accepted!**



# Wellesley™



Inspired by the romance of High Gothic, the Wellesley keeps the tradition alive. The Wellesley comes with adjustable filler panels that allow it to be fit to any firebox from 36" to 59" wide and 36" to 56" tall. Just cut the fillers to fit your situation.



Premiere Collection

The Wellesley, shown above, can be seen in person by visiting the new Galleria Pierra showroom in Dallas. Call 214-432-9999 for an appointment to tour the showroom.

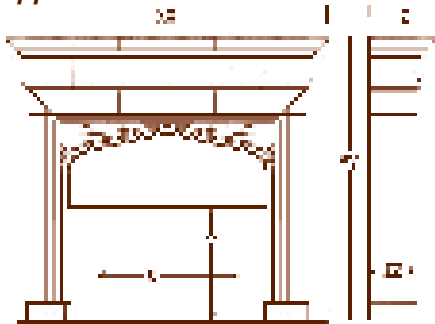

Size	X	XX	Y	YY	Z	ZZ	Hearth	Cost	Weight
59"	36"	94"	33 <sup>3</sup> / <sub>4</sub> "	84"	19 <sup>1</sup> / <sub>2</sub> "	14"	90"	\$2,860	3515



*For hearth information, please refer to page 73.*  
*For crate information, please refer to page 76.*

**Major Credit Cards Accepted!**

# Wyndmere™

Designed with classical elements including scroll legs and deeply incised flutes, the Wyndmere will enhance your most formal room settings.



Premiere Collection

Size	X	XX	Y	YY	Z	ZZ	Hearth	Cost	Weight
65"	65"	101 <sup>3</sup> / <sub>4</sub> "	51"	75"	21"	8"	108"	\$4,472	3320

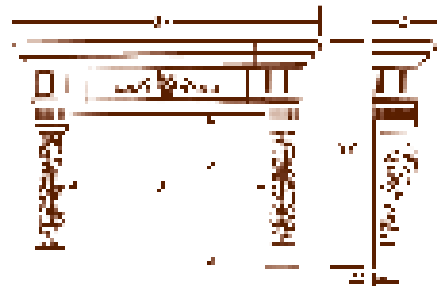

*For hearth information, please refer to page 73.*  
*For crate information, please refer to page 76.*

**Major Credit Cards Accepted!**

## The Fleet™



Shown at right is a Fleet Upper Mantel atop a 42" Windsor. On page 33, is the Regency with a customized Fleet that is approximately 15-feet tall.

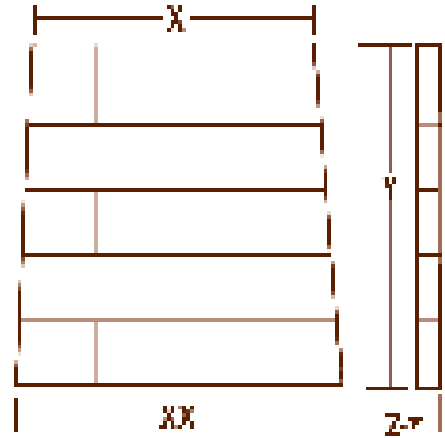

X	XX	Y	Z	ZZ	Cost	Weight
58"	68"	71"	5"	5"	\$1,495	1701

The Fleet is inventoried in Standard Tan color in the size shown.

## Upper Mantels

Add the finishing touch to your special room. Some of our Upper Mantels are inventoried for prompt delivery. Most can be either made to fit special conditions, or adjusted to fit on site to meet your specific situation. Please call for help in fitting the lower mantel of your choice with one of our upper mantels.

## The Marquessa™



The Marquessa and the Marque are variations on the Marquis Upper mantel. Either will work well with many of our lower mantels.

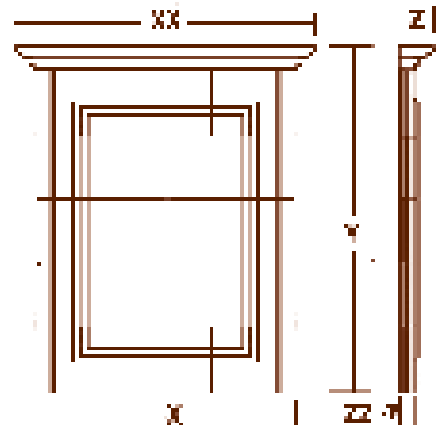

X	XX	Y	Z	ZZ	Cost	Weight
53"	62"	73½"	9⅛"	2¾"	\$1,799	1132

The Marquessa is inventoried in Standard Tan color in the size shown.



## The Providence™

The Providence upper mantel will fit on many of our lower mantels. Imagine it on a Provence Petite 42". The look is very different from the regular full height Provence.

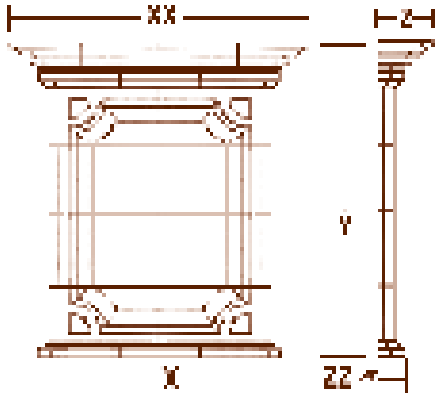

X	XX	Y	Z	ZZ	Cost	Weight
51"	64"	71½"	12"	5½"	\$2,251	1490

The Providence is inventoried in Standard Tan color in the size shown.

## Upper Mantels

Add the finishing touch to your special room. Some of our Upper Mantels are inventoried for prompt delivery. Most can be either made to fit special conditions, or adjusted to fit on site to meet your specific situation. Please call for help in fitting the lower mantel of your choice with one of our upper mantels.

## The Marque™

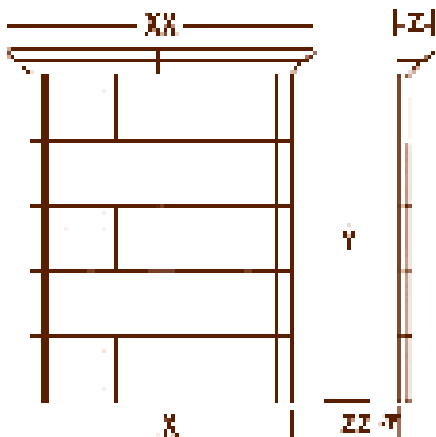

X	XX	Y	Z	ZZ	Cost	Weight
53"	62"	73½"	9"	2¼"	\$1,789	1132

The Marque is inventoried in Standard Tan color in the size shown.



## The Scarville™



Taken from the Scarsdale Full Height, the Scarville Upper Mantel is available in two widths. Height may be varied by cutting to fit on site, or ordering additional center stones.

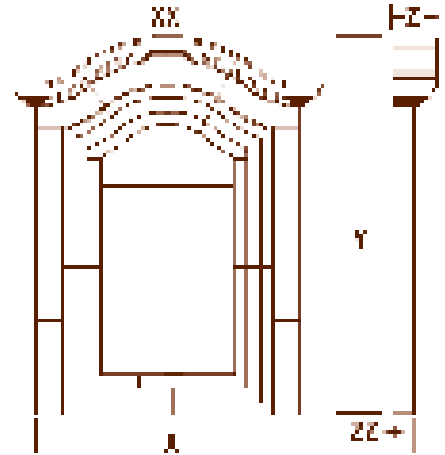

X	XX	Y	Z	ZZ	Cost	Weight
79"	86 <sup>3</sup> / <sub>4</sub> "	111 <sup>3</sup> / <sub>4</sub> "	8 <sup>3</sup> / <sub>8</sub> "	3 <sup>3</sup> / <sub>8</sub> "	\$3,250	2585
91 <sup>1</sup> / <sub>4</sub> "	99"	131"	8 <sup>3</sup> / <sub>8</sub> "	3 <sup>3</sup> / <sub>8</sub> "	\$4,599	5650

## Upper Mantels

Add the finishing touch to your special room. Some of our Upper Mantels are inventoried for prompt delivery. Most can be either made to fit special conditions, or adjusted to fit on site to meet your specific situation. Please call for help in fitting the lower mantel of your choice with one of our upper mantels.

## The Summerville™



Shown is a Summerville Upper Mantel atop a Windsor. (The unit has been faux-painted.)

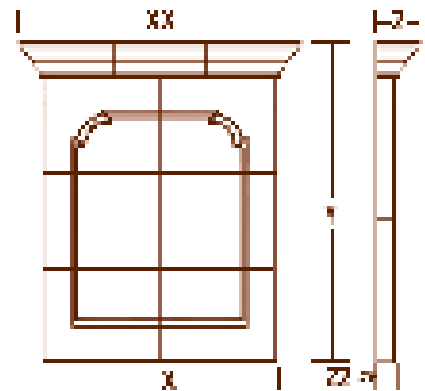

X	XX	Y	Z	ZZ	Cost	Weight
66"	80"	72"	12"	5"	\$1,989	1683

The Summerville is inventoried in Standard Tan color in the size shown.



## The Colonna™

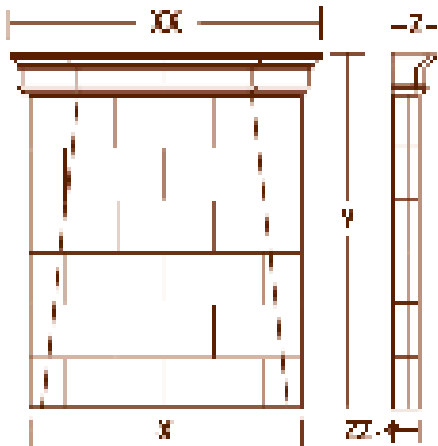

X	XX	Y	Z	ZZ	Cost	Weight
66"	71 <sup>3</sup> / <sub>4</sub> "	71 <sup>1</sup> / <sub>4</sub> "	8 <sup>3</sup> / <sub>4</sub> "	5 <sup>1</sup> / <sub>4</sub> "	\$3,095	3150

## Upper Mantels

These newer upper mantels are shown on the Windsor 48" to help visualize how they might work in your home.

## The Copperfield™

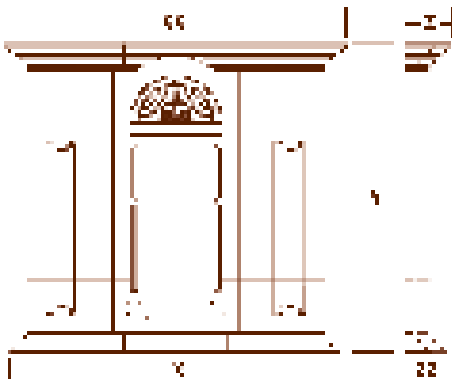

X	XX	Y	Z	ZZ	Cost	Weight
64"	74 <sup>3</sup> / <sub>4</sub> "	66"	9 <sup>1</sup> / <sub>2</sub> "	8"	\$3,194	2576

Due to the complexity of design, the Colonna, Copperfield, Villanova, and Coventry upper mantels are not adjustable. However, they should fit a wide variety of our standard lower mantels.



## The Villanova™

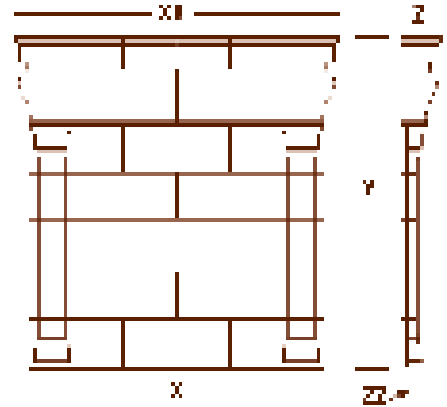

## Upper Mantels

These newer upper mantels are shown on the Windsor 48" to help visualize how they might work in your home.

X	XX	Y	Z	ZZ	Cost	Weight
66"	71 <sup>3</sup> / <sub>4</sub> "	71 <sup>1</sup> / <sub>4</sub> "	8 <sup>3</sup> / <sub>4</sub> "	5 <sup>1</sup> / <sub>4</sub> "	\$2,095	1683

## The Coventry™

Due to the complexity of design, the Colonna, Copperfield, Villanova, and Coventry upper mantels are not adjustable. However, they should fit a wide variety of our standard lower mantels.

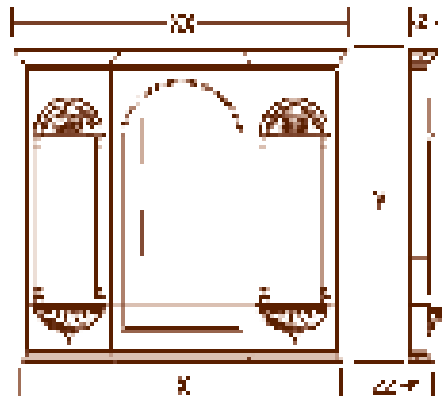

X	XX	Y	Z	ZZ	Cost	Weight
68"	71"	66"	6 <sup>1</sup> / <sub>4</sub> "	6"	\$2,095	2081





# Hearths

All hearths are optional and are not sold separately.

## Flat Hearth

2<sup>3</sup>/<sub>4</sub>" thick by 20" deep.

Comes in lengths to match each mantel. Hearth lengths are listed with each fireplace. The outer edge of the top has a continuous chamfer (bevel). Use the chart below to determine weight added by each size hearth.



The Gothic above shows the optional flat hearth.

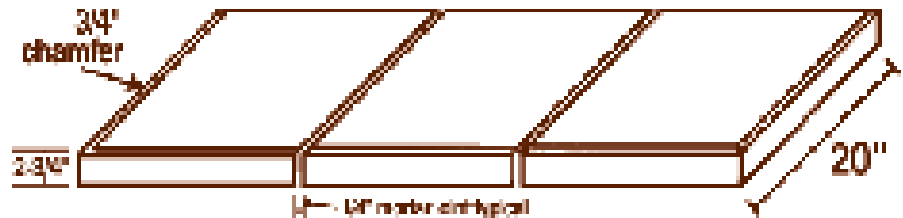

Size	Unit Price	Ship wt.	Size	Unit Price	Ship wt.
57 <sup>1</sup> / <sub>2</sub> "	\$250	298	80"	\$250	420
60"	\$250	310	87"	\$250	450
64 <sup>1</sup> / <sub>4</sub> "	\$250	330	90"	\$250	475
66 <sup>1</sup> / <sub>2</sub> "	\$250	340	108"	\$250	550
70"	\$250	380	120"	\$250	610
76 <sup>1</sup> / <sub>4</sub> "	\$250	403			

(Shipping weights include 50 lbs. of packing material.)

## Raised Hearth

Comes in the same lengths as the Flat Hearth with heights up to 15". See drawing below. The hearth stones face and sit atop a solid substructure constructed by others. Use the same hearth lengths as listed with each fireplace. Please indicate the finished height desired.

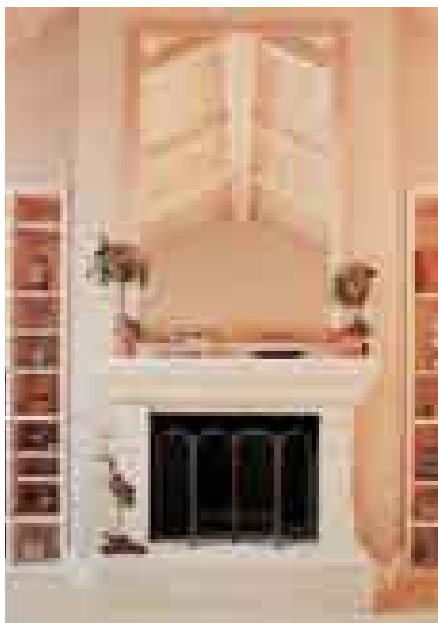

The Windsor above is shown with an optional raised hearth.

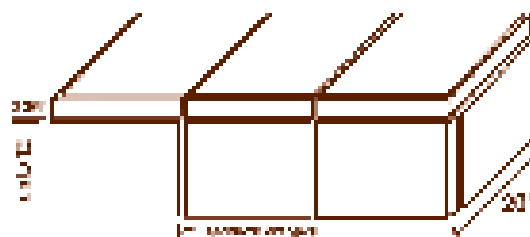

Raised Hearth Section

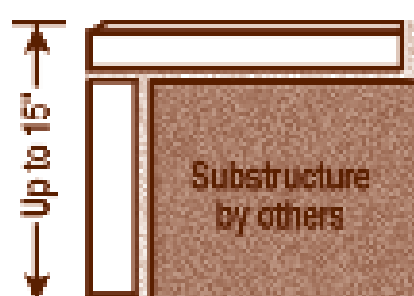

Size	Unit Price	Ship wt.
57 <sup>1</sup> / <sub>2</sub> "	\$450	538
60"	\$450	558
64 <sup>1</sup> / <sub>4</sub> "	\$450	587
66 <sup>1</sup> / <sub>2</sub> "	\$450	603
70"	\$450	652
76 <sup>1</sup> / <sub>4</sub> "	\$450	690
80"	\$450	717
87"	\$450	764
90"	\$450	790
108"	\$450	901
120"	\$450	976

(Shipping weights include 50 lbs. of packing material, and are figured for the maximum 15" height.)



# Installation Tips

Stone Magic mantels are designed to be easily installed by a mason or other construction trade professional. Care must be taken because the pieces are heavy and many of the edges are delicate. Many installations are done in existing homes, so other elements must be protected from damage during installation.



**Before starting, layout the stone to dry and verify each piece. Scaffolding may be necessary to work on the upper portions of some mantels.**



**Fireplace that has been prepared for installation. And the installer is working on leveling and setting the hearth stones.**



**Once the hearth is set, the legs are carefully put into place and tied back to the framing. Note the ties in the tops of the stones in the photo above left. At right, the mason is checking joint spacing on the next layer.**





*For security, the stones can be tied together as well as to the wall.*

*Above, the mason drills a pilot hole to anchor leg to wall.*



*As the final step, the face of the fireplace is sponged with clean water to remove any grout haze or dirt.*

*As shown above, the arch of this fireplace is externally supported until the mortar can set fully in place and final point up is done.*

*After final installation, the stone is cleaned with muriatic acid to remove any remaining dirt. Once this is done and the stone is completely dry, it can be sealed or not as desired.*



# How to Order

1. Either call or fax us, letting us know which fireplace(s) you want. We will need to know the style (Polo, Gothic, etc.), whether its a lower or full height unit, if applicable, and the firebox size (36", 42", etc.) Indicate the quantity of each desired and whether or not you want an optional flat hearth or optional raised hearth, or neither.
2. We will also need to know your billing address, phone and fax numbers, and the project name and shipping address if different from billing address. The shipping address needs to include an actual street location with the five digit zip code.
3. We will formalize a written contract for your approval. It will have all charges outlined, including crating and shipping charges, and optional color, if other than tan.
4. See Sales Policies for payment terms and shipping times.

## Crates

Add \$150 per crate required to ship your mantel. One crate is required for each mantel and separate upper mantel (including hearth if desired), except as listed.

### 2 Crates:

Anton Full Height  
 Archer Full Height  
 Brittany Full Height 48"  
 Brittany Lower 72"  
 Brownwood  
 Columbia Full Height

Falkland Full Height  
 Falkland Mid-Height  
 Grand Baroque Full Height  
 Guardians Lower Mantels  
 Guardians 39" Full Height  
 Madison U-Shaped  
 Marquis Full Height  
 Normandie Full Height  
 Provence Full Height (all sizes)  
 Radcliffe Full Height  
 Scarborough Lower Mantel  
 Scarsdale Full Height  
 Somerset Lower Mantel

### 3 Crates:

Brittany Full Height 72"  
 Guardians Full Height  
 Scarborough Full Height  
 Somerset Full Height

### 4 Crates:

Somerset Grande Full Height

*Note: Crate weights (figured at 125-lbs. each) are already included in the weights shown in the tables.*

## Color



**Standard Tan**  
 No color charge.

**Optional Buff**  
 Add \$250 per fireplace, upper mantel and hearth unit for optional colors.

**Optional White**

Shown at left are photos of our standard color tan, and the two optional colors of buff and white. We have tried to make these as accurate as possible, but if color is critical, we can send you actual samples.

Copyright © 2009

The enclosed mantel designs are protected through copyright laws. Anyone copying these mantels in whole or in part will be subject to litigation. This material is protected by copyright and cannot be reproduced in whole or in part without the written consent of Stone Magic.



**Major Credit Cards Accepted!**

*For hearth information, please refer to page 73.*

*For crate information, please refer to page 76.*

# Sales Policies

- Terms:** Prepaid. C.O.D. only with customer pickup at our factory in Dallas, Texas. Major credit cards accepted.
- Prices:** Prices are subject to change without notice and do not include shipping. Add freight costs and \$150 per crate required for shipping. See page 78 for number of crates required for each mantel.
- Color:** Our standard color of tan is fine grained in texture and an off-white color. As with any natural product, there will be only a slight variation, if any, in color. See page 78 for standard and optional colors.
- Shipments:** All orders are produced and shipped from our factory in Dallas, Texas. Customer is responsible for all freight charges. All claims on apparent or concealed shipping damage should be reported in writing to Stone Magic immediately. Save all broken stones and all packing material. Stone Magic will remake and ship any chipped or broken piece reported within two weeks of delivery.
- Delivery Note:** Your truck driver will not take your crate off the truck for you. We always request a lift gate. However, this is not always possible, so please have two or three of your people ready to unload from the trucker's tailgate. Please furnish us a fax number to which the Bill of Lading can be sent to help control delivery at your end.
- Deposit:** You will be sent a proposal for your signature, based on the items you wish to order. This will include freight to the shipping address that you furnish. On non-inventory items, a 50% deposit is required before production can begin. Balance is due prior to shipment. A final invoice will be issued at the time of production completion. Optional color or special sizing orders are not inventoried and are noncancelable once production has started.
- Inventory:** Certain styles are inventoried (Tan only) and available for shipment within seven working days of the receipt of the order, barring any unforeseen problems. These must be 100% prepaid. Please check with the sales office for availability.
- Completion:** Allow six weeks for production on non-inventory, optional color and special sized orders.
- Holding:** If you are not able to accept delivery upon completion of production, Stone Magic will hold your order for up to four weeks from our completion date, provided the balance is paid in full.
- Returns:** Returns on inventory items only will be accepted, provided the original crate is intact. All returns will be subject to a restocking fee and must be pre-approved by Stone Magic. Return freight charges are the responsibility of the customer. There will be no refund of original shipping charges.
- Installation:** All Stone Magic mantels are sold directly out of the catalog, thus shop drawings will not be furnished for approvals. However, an installation drawing showing piece marks, etc., will be sent with the material. A 5 gallon bucket of product sand is included with each order. This is to be used for pointing the joints or any minor patching required. Instructions are included with the sand on mixing and cleaning. The larger mantels include additional buckets of sand.
- Warranty:** Our products are warranted to be free from defect, except those related to the natural color variation inherent in the production of cast stone. Any defective product will be replaced.
- Sales Tax:** Sales tax is applicable to Texas sales only. This includes orders picked up by customers at our factory. No other states are taxable.





... live according  
to nature.

*- Lucius Annaeus Seneca (4BC-65AD)*



Natural Cut Stone by  
**Stone Origins**

Call for FREE Catalog!  
**(888) 398-1299**

Visit us Online Today!  
[www.stoneorigins.com](http://www.stoneorigins.com)





*Legendary Views,  
Coast to Coast*

STONE  LEGENDS

301 PLEASANT DRIVE

| DALLAS, TX 75042

| 800.398.1199

| [www.stonelegends.com](http://www.stonelegends.com)



*Stone Magic*  
800-597-3606  
301 Pleasant Drive  
Dallas, TX 75217

